



**VORGEN®**

**2024 Ocak  
TL Fiyat Listesi**



[www.vorgen.com](http://www.vorgen.com)



**THE RED  
POWER FOR  
THE PROFESSIONALS**

**PROFESYONELLER İÇİN KIRMIZI GÜÇ**

[WWW.VORGEN.COM](http://WWW.VORGEN.COM)

## HAKKIMIZDA / ABOUT

1975 yılında Talaşlı imalat faaliyetiyle sektöre adım atan BAHÇIVAN Kesici Takımlar , 1988 yılında sektörde oluşan torna Kater talebi karşısında emek ve yatırımlarını bu doğrultuda kanaliz ederek Kesici Uç Bağlama Sistemleri üretimine başlamış. 1996 yılında piyasada oluşan yeni talepleri karşılamak, ürün hassasiyetini en üst düzeye çıkarmak, geriye- ile- riye bütünleşik üretim yapmak amacıyla son teknoloji CNC tezgahlarını ma- kine parkuruna dahil etmiştir.

35 yıla yakın zamanı geride bırakan Bahçivan Makine 4000m<sup>2</sup> ye yakın ka- palı alanı, otomasyon destekli CNC makineleri, kalifiye ekibi ile Talaşlı İma- lat sektöründe kullanılan kesici uç bağlama sistemleri üreten lider firmalar arasında yüzde 100 yerli üretimle üreterek ülke ekonomisine ve sanayisi- ne katkıda bulunmakta, Sürekli öğrenen ve gelişen organizasyon yapısı ile üretimde sürekli iyileştirmeyi hedef almakta, Yönetim ve Üretimini ISO 9001:2000 kalite yönetim sistemiyle güçlendirip yurt içi ve yurt dışı paza- rında önemli rol üstlenmektedir.

ve bugün, BAHÇIVAN kesici takımlar bu anlayışla, müşteri ve tedarikçilerin- den gelen yorumları değerlendirerek ürün çeşitliliği ve toplam kalite anlayı- şıyla öncü konuma gelmenin, yurt içi ve yurt dışı pazarlarda aranılan marka haline gelmenin haklı gururunu siz değerli müşterilerimizle ve tedarikçileri- mizle paylaşmaktayız.

In 1975, VORGEN entered the industry with metal working activities. In 1988, in response to the demand for lathe cutter systems in the industry, the company directed its efforts and investments towards producing Cut- ting Tool Holding Systems. In 1996, to meet new market demands, maxi- mize product precision, and integrate backward-forward production, the company incorporated state-of-the-art CNC machines into its machinery lineup.

With nearly 35 years of experience, VORGEN is among the leading com- panies in the metalworking industry that produce cutting tool holding sys- tems, with close to 4000m<sup>2</sup> of enclosed space, automation-supported CNC machines, and a qualified team. The company contributes to the country's economy and industry with 100% domestic production, aiming for conti- nuous improvement in production with a constantly learning and evolving organizational structure. Strengthening its management and production with the ISO 9001:2000 quality management system, the company plays a significant role in both domestic and international markets.

Today, VORGEN takes pride in becoming a pioneer in product variety and total quality understanding, and in becoming a sought-after brand in domestic and international markets, by evaluating feedback from custo- mers and suppliers.

# SERTİFİKALAR CERTIFICATES



# İÇİNDEKİLER CONTENTS



**D SİSTEM DIŞ TORNA  
KATERLERİ** 10  
D SYSTEM EXTERNAL  
LATHE TOOL HOLDERS 18



**M SİSTEM DIŞ TORNA  
KATERLERİ** 20  
M SYSTEM EXTERNAL  
LATHE TOOL HOLDERS 21



**C SİSTEM DIŞ TORNA  
KATERLERİ** 23  
C SYSTEM EXTERNAL  
LATHE TOOL HOLDERS 25



**S SİSTEM DIŞ TORNA  
KATERLERİ** 28  
S SYSTEM EXTERNAL  
LATHE TOOL HOLDERS 37



**P SİSTEM DIŞ TORNA  
KATERLERİ** 38  
P SYSTEM EXTERNAL  
LATHE TOOL HOLDERS 39



**TIRTIR DIŞ  
TORNA KATERLERİ** 40  
INCHINEMUON CLAMP  
OUTSIDE DIAMETER 41



**D SİSTEM DELİK  
TORNA KATERLERİ** 44  
D SYSTEM  
BORING BARS 48



**M SİSTEM DELİK  
TORNA KATERLERİ** 50  
M SYSTEM  
BORING BARS 52



**C SİSTEM DELİK  
TORNA KATERLERİ** 53  
C SYSTEM  
BORING BARS 54



**S SİSTEM DELİK  
TORNA KATERLERİ** 56  
S SYSTEM  
BORING BARS 64



**VİDA TAKIMLARI** 66  
SCREW PLUGS 67



**DIŞ ÇAP KANAL AÇMA  
TAKIMLARI** 70  
EXTERNAL GROOVING  
TOOLHOLDERS 83



**DIŞ ÇAP ALIN KANAL  
AÇMA TAKIMLARI** 85  
FACE EXTERNAL  
GROOVING TOOLHOLDERS 86



**DELİK İÇİ KANAL  
TAKIMLARI** 87  
INTERNAL GROOVING  
TOOLHOLDERS 90



**PAH FREZELER** 91  
CHAMFERING END MILLS 92



**FREZE TAKIMLARI** 94  
MILLING TOOLS 121



**PARMAK FREZE  
TAKIMLARI** 124  
END MILLING  
TOOLHOLDERS 138



**DEĞİŞTİRİLEBİLİR UÇLU  
MODÜLER FREZELER** 139  
MODULAR END MILLS WITH  
CHANGEABLE INSERT 142



**DELİK DELME VE  
TORNALAMA** 144  
HOLE DRILLAND LATHE 159



**DİSK FREZE - T FREZE** 160  
DISK END T MILLING 161













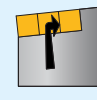

**YEDEK PARÇALAR** 162  
SPARE PARTS 169







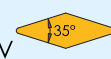

# External Turning Code Key

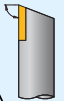
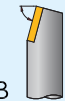
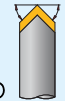

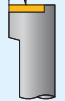
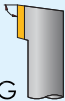

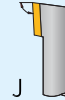

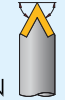
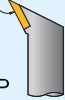
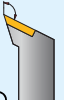
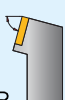
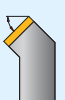
Extract from ISO

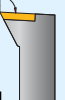
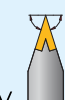
<b>D</b>	<b>W</b>	<b>L</b>	<b>N</b>	<b>R</b>	<b>25</b>	<b>25</b>	<b>M</b>	<b>08</b>
1	2	3	4	5	6	7	8	9

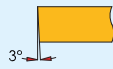
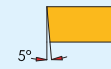
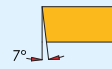
1 Clamping System				
Top Clamping  <b>C</b>	Top and hole clamping  <b>D</b>	Wedge clamping  <b>M</b>	Lever Clamping  <b>P</b>	Screw Clamping  <b>S</b>

2 Insert Shape		
<b>C</b> 	<b>E</b> 	<b>D</b> 
<b>K</b> 	<b>R</b> 	<b>S</b> 
<b>T</b> 	<b>V</b> 	<b>W</b> 

3 Approach Angle					
<b>A</b> 90° 	<b>B</b> 75° 	<b>D</b> 45° 	<b>E</b> 60° 	<b>F</b> 90° 	<b>G</b> 90° 
<b>H</b> 107,5° 	<b>J</b> 93° 	<b>K</b> 75° 	<b>L</b> 95° 	<b>N</b> 63° 	<b>P</b> 117,5° 
<b>Q</b> 107,5° 	<b>R</b> 75° 	<b>S</b> 45° 	<b>T</b> 60° 	<b>U</b> 93° 	<b>V</b> 72,5° 



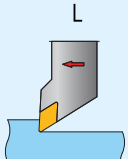
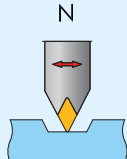
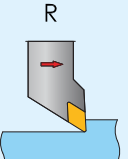





4 Insert Clearance Angle		
<b>A</b> 3° 	<b>B</b> 5° 	<b>C</b> 7° 
<b>D</b> 15° 	<b>E</b> 20° 	<b>F</b> 25° 
<b>G</b> 30° 	<b>N</b> 0° 	<b>P</b> 11° 

5 Hand of Tool		
<b>L</b> 	<b>N</b> 	<b>R</b> 

6 Shank Height h mm

8 = 08 mm 16 = 16 mm 25 = 25 mm

7 Shank Width b mm

8 = 08 mm 16 = 16 mm 25 = 25 mm

8 Tool Length L mm				
				
A = 32	F = 80	M = 150	R = 200	V = 400
B = 40	H = 100	N = 160	S = 250	W = 450
C = 50	K = 125	P = 170	T = 300	Y = 500
D = 60	L = 140	Q = 180	U = 350	X = Special

9 Cutting edge length mm		
<b>C</b> 	<b>E</b> 	<b>D</b> 
<b>K</b> 	<b>R</b> 	<b>S</b> 
<b>T</b> 	<b>V</b> 	<b>W</b> 



[www.vorgen.com](http://www.vorgen.com)

 **VORGEN®**

# **D SİSTEM DIŞ TORNA KATERLERİ**

**D SYSTEM EXTERNAL LATHE  
TOOL HOLDERS**

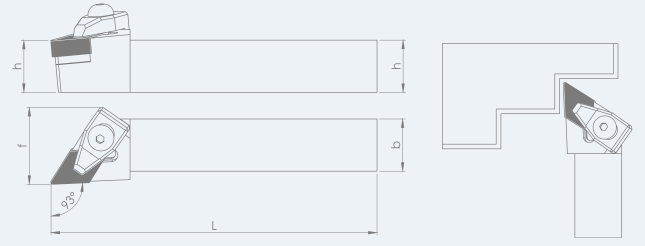
**TEKNİK ÇİZİM / TECHNICAL DRAWING**

TAKIM KODU ORDERING CODE	ÜRÜN KODU PRODUCT CODE	KATER ÖLÇÜLERİ DIMENSIONS (mm)	TL FİYAT TL PRICE
-----------------------------	---------------------------	-----------------------------------	----------------------

**DDJNR/L 93°**

Sol / Left	Sağ / Right	h	b	L	f
------------	-------------	---	---	---	---



DDJNR/L - 1616 - H11	VRD1001	VRD1002	16	16	105	20
DDJNR/L - 2020 - K11	VRD1003	VRD1004	20	20	125	25
DDJNR/L - 2525 - M11	VRD1005	VRD1006	25	25	150	32
DDJNR/L - 2020 - K15	VRD1007	VRD1008	20	20	125	25
DDJNR/L - 2525 - M15	VRD1009	VRD1010	25	25	150	32
DDJNR/L - 3232 - P15	VRD1011	VRD1012	32	32	170	40
DDJNR/L - 4040 - S15	VRD1013	VRD1014	40	40	250	50
DDJNR/L - 2020 - K1504	VRD1015	VRD1016	20	20	125	25
DDJNR/L - 2525 - M1504	VRD1017	VRD1018	25	25	150	32
DDJNR/L - 3232 - P1504	VRD1209	VRD1210	32	32	170	40

DNM..	₺917
11 04..	₺917
	₺982
	₺924
DNM..	₺982
15 06..	₺1.145
	₺1.944
	₺924
DNM..	₺982
15 04..	₺1.145

**TEKNİK ÇİZİM / TECHNICAL DRAWING**

TAKIM KODU ORDERING CODE	ÜRÜN KODU PRODUCT CODE	KATER ÖLÇÜLERİ DIMENSIONS (mm)	KESİCİ UÇ INSERT	TL FİYAT TL PRICE
-----------------------------	---------------------------	-----------------------------------	---------------------	----------------------

**DDNNN 62.5°**

h	b	L	f
---	---	---	---



DDNNN - 2020 - K15	VRN1020	20	20	125	10
DDNNN - 2525 - M15	VRN1022	25	25	150	12,5
DDNNN - 3232 - P15	VRN1024	32	32	170	16
DDNNN - 4040 - S15	VRN1494	40	40	250	50
DDNNN - 2020 - K1504	VRN1495	20	20	125	10
DDNNN - 2525 - M1504	VRN1496	25	25	150	12,5
DDNNN - 2525 - M11	VRN1026	25	25	150	12,5
DDNNN - 2020 - K11	VRN1028	20	20	125	10

	₺917
DNM..	₺982
15 06..	₺1.145
	₺1.944
DNM..	₺917
15 04..	₺982
DNM..	₺982
11 04..	₺917



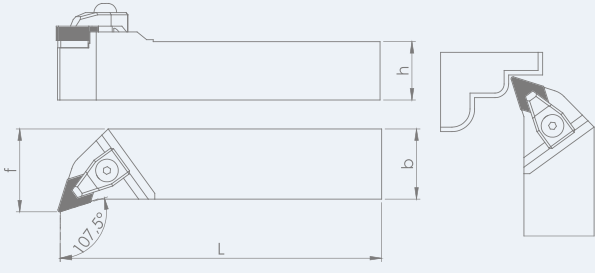

TEKNİK ÇİZİM / TECHNICAL DRAWING



TAKIM KODU ORDERING CODE	ÜRÜN KODU PRODUCT CODE	KATER ÖLÇÜLERİ DIMENSIONS (mm)	KESİCİ UÇ INSERT	TL FİYAT TL PRICE
-----------------------------	---------------------------	-----------------------------------	---------------------	----------------------

**DDHNR/L 107.5°**

Sol / Left	Sağ / Right	h	b	L	f			
DDHNR/L - 2020 - K15	VRD1019	VRD1030	20	20	125	25		₺917
DDHNR/L - 2525 - M15	VRD1021	VRD1032	25	25	150	32	<b>DNM.. 15 06..</b>	₺982
DDHNR/L - 3232 - P15	VRD1023	VRD1034	32	32	170	40		₺1.145
DDHNR/L - 4040 - S15	VRD1211	VRD1212	40	40	250	50		₺1.944

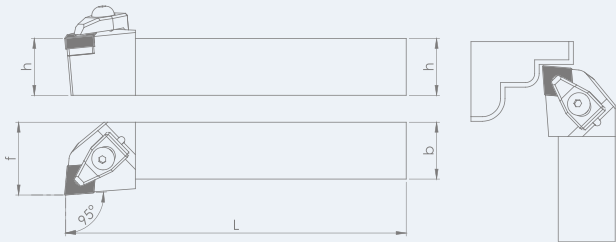

TEKNİK ÇİZİM / TECHNICAL DRAWING



TAKIM KODU ORDERING CODE	ÜRÜN KODU PRODUCT CODE	KATER ÖLÇÜLERİ DIMENSIONS (mm)	KESİCİ UÇ INSERT	TL FİYAT TL PRICE
-----------------------------	---------------------------	-----------------------------------	---------------------	----------------------

**DCLNR/L 95°**

Sol / Left	Sağ / Right	h	b	L	f			
DCLNR/L - 2020 - K12	VRD1025	VRD1036	20	20	125	25		₺917
DCLNR/L - 2525 - M12	VRD1027	VRD1038	25	25	150	32	<b>CNM.. 12 04..</b>	₺982
DCLNR/L - 3232 - P12	VRD1029	VRD1040	32	32	170	40		₺1.145
DCLNR/L - 4040 - S12	VRD1031	VRD1042	40	40	250	50		₺1.944
DCLNR/L - 2525 - M16	VRD1033	VRD1044	25	25	150	32	<b>CNM.. 16 06..</b>	₺1.156
DCLNR/L - 3232 - P16	VRD1035	VRD1046	32	32	170	40		₺1.271
DCLNR/L - 4040 - S16	VRD1037	VRD1048	40	40	250	50		₺2.197
DCLNR/L - 2525 - M19	VRD1039	VRD1050	25	25	150	32	<b>CNM.. 19 06..</b>	₺1.156
DCLNR/L - 3232 - P19	VRD1041	VRD1052	32	32	170	40		₺1.508
DCLNR/L - 4040 - S19	VRD1043	VRD1054	40	40	250	50		₺2.197
DCLNR/L - 2020 - K09	VRD1213	VRD1214	20	20	125	25	<b>CNM.. 09 03..</b>	₺982
DCLNR/L - 2525 - M09	VRD1045	VRD1056	25	25	150	32		₺982



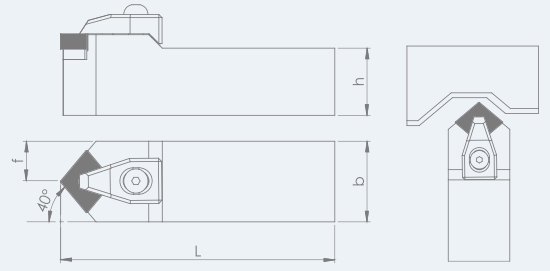

**TEKNİK ÇİZİM / TECHNICAL DRAWING**

TAKIM KODU ORDERING CODE	ÜRÜN KODU PRODUCT CODE	KATER ÖLÇÜLERİ DIMENSIONS (mm)	KESİCİ UÇ INSERT	TL FİYAT TL PRICE
<b>DCXNN 40°</b>		<b>h b L f</b>		
DCXNN - 2020 - K12	VRN1058	20 20 125 10		₺917
DCXNN - 2525 - M12	VRN1060	25 25 150 12,5	<b>CNM.. 12 04..</b>	₺982
DCXNN - 3232 - P12	VRN1062	32 32 170 16		₺1.145
DCXNN - 2525 - M16	VRN1064	25 25 150 12,5	<b>CNM.. 16 06..</b>	₺1.156
DCXNN - 3232 - P16	VRN1066	32 32 170 16		₺1.271
DCXNN - 3232 - P19	VRN1497	32 32 170 16	<b>CNM.. 19 06..</b>	₺1.508

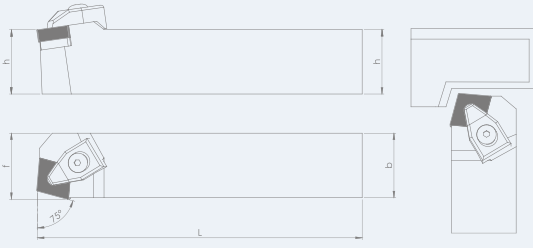

**TEKNİK ÇİZİM / TECHNICAL DRAWING**

TAKIM KODU ORDERING CODE	ÜRÜN KODU PRODUCT CODE	KATER ÖLÇÜLERİ DIMENSIONS (mm)	KESİCİ UÇ INSERT	TL FİYAT TL PRICE
<b>DCKNR/L 75°</b>		<b>Sol / Left Sağ / Right h b L f</b>		
DCKNR/L - 2020 - K12	VRD1047 VRD1068	20 20 125 25		₺917
DCKNR/L - 2525 - M12	VRD1049 VRD1070	25 25 150 32	<b>CNM.. 12 04..</b>	₺982
DCKNR/L - 3232 - P12	VRD1051 VRD1072	32 32 170 40		₺1.145
DCKNR/L - 2525 - M16	VRD1053 VRD1074	25 25 150 32	<b>CNM.. 16 06..</b>	₺1.156
DCKNR/L - 3232 - P16	VRD1055 VRD1076	32 32 170 40		₺1.271
DCKNR/L - 2020 - K09	VRD1213 VRD1214	20 20 125 25	<b>CNM.. 09 03..</b>	₺917
DCKNR/L - 2525 - M09	VRD1057 VRD1078	25 25 150 32		₺982
DCKNR/L - 3232 - P19	VRD1197 VRD1198	32 32 170 40	<b>CNM.. 19 06..</b>	₺1.508
DCKNR/L - 4040 - S19	VRD1199 VRD1200	40 40 250 50		₺2.197

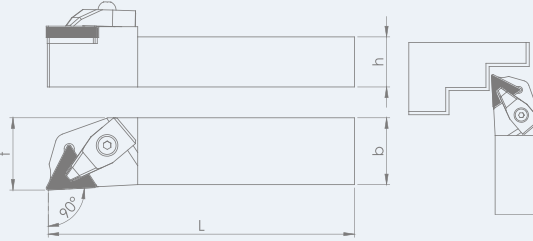

## TEKNİK ÇİZİM / TECHNICAL DRAWING

TAKIM KODU ORDERING CODE	ÜRÜN KODU PRODUCT CODE	KATER ÖLÇÜLERİ DIMENSIONS (mm)	KESİCİ UÇ INSERT	TL FİYAT TL PRICE				
<b>DCBNR/L 75°</b>	<b>Sol / Left</b>	<b>Sağ / Right</b>	<b>h</b>	<b>b</b>	<b>L</b>	<b>f</b>		
DCBNR/L - 2020 - K12	VRD1059	VRD1080	20	20	125	17		₺917
DCBNR/L - 2525 - M12	VRD1061	VRD1082	25	25	150	22	<b>CNM.. 12 04..</b>	₺982
DCBNR/L - 3232 - P12	VRD1063	VRD1084	32	32	170	29		₺1.145
DCBNR/L - 2525 - M16	VRD1065	VRD1086	25	25	150	22	<b>CNM.. 16 06..</b>	₺1.156
DCBNR/L - 3232 - P16	VRD1067	VRD1088	32	32	170	29		₺1.271
DCBNR/L - 3232 - P19	VRD1215	VRD1216	32	32	170	16	<b>CNM.. 19 06..</b>	₺1.508



## TEKNİK ÇİZİM / TECHNICAL DRAWING

TAKIM KODU ORDERING CODE	ÜRÜN KODU PRODUCT CODE	KATER ÖLÇÜLERİ DIMENSIONS (mm)	KESİCİ UÇ INSERT	TL FİYAT TL PRICE				
<b>DTGNR/L 90°</b>	<b>Sol / Left</b>	<b>Sağ / Right</b>	<b>h</b>	<b>b</b>	<b>L</b>	<b>f</b>		
DTGNR/L - 2020 - K22	VRD1069	VRD1090	20	20	125	25		₺917
DTGNR/L - 2525 - M22	VRD1071	VRD1092	25	25	150	32	<b>TNM.. 22 04..</b>	₺982
DTGNR/L - 3232 - P22	VRD1073	VRD1094	32	32	170	40		₺1.145
DTGNR/L - 4040 - S22	VRD1075	VRD1096	40	40	250	50		₺2.197
DTGNR/L - 2020 - K16	VRD1077	VRD1098	20	20	125	25		₺917
DTGNR/L - 2525 - M16	VRD1079	VRD1100	25	25	150	32	<b>TNM.. 16 04..</b>	₺982
DTGNR/L - 3232 - P16	VRD1081	VRD1102	32	32	170	40		₺1.145

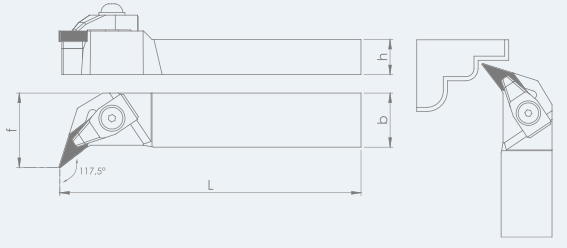
**TEKNİK ÇİZİM / TECHNICAL DRAWING**

TAKIM KODU ORDERING CODE	ÜRÜN KODU PRODUCT CODE	KATER ÖLÇÜLERİ DIMENSIONS (mm)	KESİCİ UÇ INSERT	TL FİYAT TL PRICE
-----------------------------	---------------------------	-----------------------------------	---------------------	----------------------

**DVQNR/L 117,5°**

Sol / Left	Sağ / Right	h	b	L	f
------------	-------------	---	---	---	---

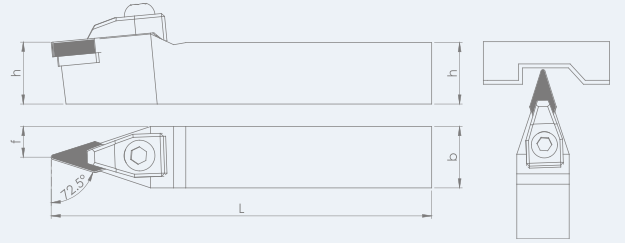

DVQNR/L - 2020 - K16	VRD1083	VRD1104	20	20	125	25
DVQNR/L - 2525 - M16	VRD1085	VRD1106	25	25	150	32
DVQNR/L - 3232 - P16	VRD1087	VRD1108	32	32	170	40

**₺917**
**VNM..  
16 04..**
**₺982**
**₺1.145**

**TEKNİK ÇİZİM / TECHNICAL DRAWING**

TAKIM KODU ORDERING CODE	ÜRÜN KODU PRODUCT CODE	KATER ÖLÇÜLERİ DIMENSIONS (mm)	KESİCİ UÇ INSERT	TL FİYAT TL PRICE
-----------------------------	---------------------------	-----------------------------------	---------------------	----------------------

**DVVNN 72,5°**

h	b	L	f
---	---	---	---



DVVNN - 2020 - K16	VRN1110		20	20	125	25
DVVNN - 2525 - M16	VRN1112		25	25	150	32
DVVNN - 3232 - P16	VRN1114		32	32	170	40

**₺917**
**VNM..  
16 04..**
**₺982**
**₺1.145**

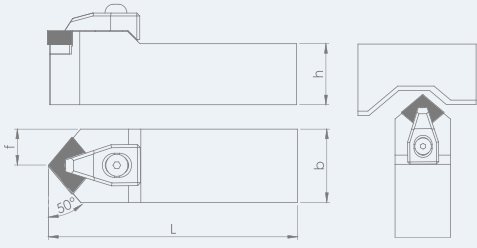

TEKNİK ÇİZİM / TECHNICAL DRAWING



TAKIM KODU ORDERING CODE	ÜRÜN KODU PRODUCT CODE	KATER ÖLÇÜLERİ DIMENSIONS (mm)	KESİCİ UÇ INSERT	TL FİYAT TL PRICE
<b>DCMNN 50°</b>		<b>h</b> <b>b</b> <b>L</b> <b>f</b>		
DCMNN - 2020 - K12	VRN1116	20 20 125 10	<b>CNM.. 12 04..</b>	₺917
DCMNN - 2525 - M12	VRN1118	25 25 150 12,5		₺982
DCMNN - 3232 - P12	VRN1120	32 32 170 16	<b>CNM.. 16 06..</b>	₺1.145
DCMNN - 3232 - P16	VRN1122	32 32 170 16		₺1.271
DCMNN - 3232 - P19	VRD1201	32 32 170	<b>CNM.. 19 06..</b>	₺1.508
DCMNN - 4040 - S19	VRD1202	40 40 250		₺2.197

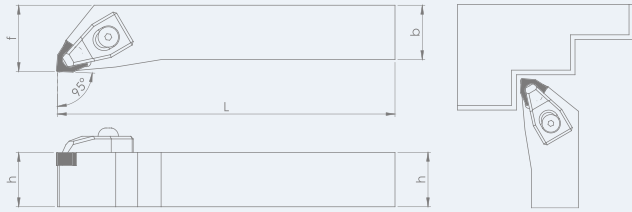

TEKNİK ÇİZİM / TECHNICAL DRAWING



TAKIM KODU ORDERING CODE	ÜRÜN KODU PRODUCT CODE	KATER ÖLÇÜLERİ DIMENSIONS (mm)	KESİCİ UÇ INSERT	TL FİYAT TL PRICE
<b>DWLNR/L 95°</b>		<b>Sol / Left</b> <b>Sağ / Right</b> <b>h</b> <b>b</b> <b>L</b> <b>f</b>		
DWLNR/L - 1616 - K06	VRD1089	VRD1124 16 16 125 20		₺917
DWLNR/L - 2020 - K06	VRD1091	VRD1126 20 20 125 25	<b>WNM.. 06 T3..</b>	₺917
DWLNR/L - 2525 - M06	VRD1093	VRD1128 25 25 150 32		₺982
DWLNR/L - 2020 - K08	VRD1095	VRD1130 20 20 125 25		₺917
DWLNR/L - 2525 - M08	VRD1097	VRD1132 25 25 150 32	<b>WNM.. 08 04..</b>	₺982
DWLNR/L - 3232 - P08	VRD1099	VRD1134 32 32 170 40		₺1.145
DWLNR/L - 4040 - S08	VRD1101	VRD1136 40 40 250 50		₺1.944

**TEKNİK ÇİZİM / TECHNICAL DRAWING**

TAKIM KODU ORDERING CODE	ÜRÜN KODU PRODUCT CODE	KATER ÖLÇÜLERİ DIMENSIONS (mm)	KESİCİ UÇ INSERT	TL FİYAT TL PRICE
-----------------------------	---------------------------	-----------------------------------	---------------------	----------------------

**DSKNR/L 75°**

Sol / Left	Sağ / Right	h	b	L	f
------------	-------------	---	---	---	---



DSKNR/L - 2020 - K12	VRD1103	VRD1138	20	20	125	25	₺917
DSKNR/L - 2525 - M12	VRD1105	VRD1140	25	25	150	32	<b>SNM.. 12 04..</b> ₺982
DSKNR/L - 3232 - P12	VRD1107	VRD1142	32	32	170	40	₺1.145
DSKNR/L - 3232 - P15	VRD1109	VRD1144	32	32	170	40	<b>SNM.. 15 06..</b> ₺1.271

**TEKNİK ÇİZİM / TECHNICAL DRAWING**

TAKIM KODU ORDERING CODE	ÜRÜN KODU PRODUCT CODE	KATER ÖLÇÜLERİ DIMENSIONS (mm)	KESİCİ UÇ INSERT	TL FİYAT TL PRICE
-----------------------------	---------------------------	-----------------------------------	---------------------	----------------------

**DSDNN 45°**

h	b	L	f
---	---	---	---



DSDNN - 2020 - K12	VRN1146		20	20	125	10	₺917
DSDNN - 2525 - M12	VRN1148		25	25	150	12,5	<b>SNM.. 12 04..</b> ₺982
DSDNN - 3232 - P12	VRN1150		32	32	170	16	₺1.145
DSDNN - 3232 - P15	VRN1152		32	32	170	16	<b>SNM.. 15 04..</b> ₺1.271
DSDNN - 3232 - P19	VRN1493		32	32	170	16	<b>SNM.. 19 04..</b> ₺1.508



## TEKNİK ÇİZİM / TECHNICAL DRAWING

TAKIM KODU ORDERING CODE	ÜRÜN KODU PRODUCT CODE	KATER ÖLÇÜLERİ DIMENSIONS (mm)	KESİCİ UÇ INSERT	TL FİYAT TL PRICE				
<b>DSSNR/L 45°</b>	<b>Sol / Left</b>	<b>Sağ / Right</b>	<b>h</b>	<b>b</b>	<b>L</b>	<b>f</b>		
DSSNR/L - 2020 - K12	VRD1111	VRD1154	20	20	125	25	SNM.. 12 04..	₺917
DSSNR/L - 2525 - M12	VRD1113	VRD1156	25	25	150	32		₺982
DSSNR/L - 3232 - P12	VRD1115	VRD1158	32	32	170	40		₺1.145
DSSNR/L - 2525 - M15	VRD1117	VRD1160	25	25	150	32	SNM.. 15 04..	₺1.156
DSSNR/L - 3232 - P15	VRD1119	VRD1162	32	32	170	40		₺1.271
DSSNR/L - 4040 - S15	VRD1217	VRD1218	40	40	250	50		₺1.944
DSSNR/L - 2525 - M19	VRD1121	VRD1164	25	25	150	32	SNM.. 19 06..	₺1.156
DSSNR/L - 3232 - P19	VRD1123	VRD1166	32	32	170	40		₺1.504
DSSNR/L - 4040 - S19	VRD1205	VRD1206	40	40	250	50		₺2.197

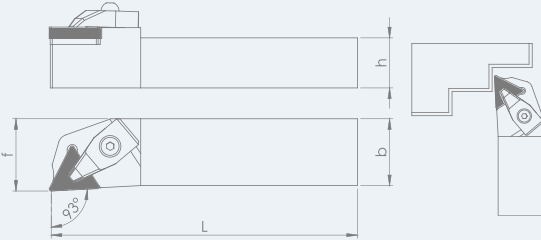

## TEKNİK ÇİZİM / TECHNICAL DRAWING

TAKIM KODU ORDERING CODE	ÜRÜN KODU PRODUCT CODE	KATER ÖLÇÜLERİ DIMENSIONS (mm)	KESİCİ UÇ INSERT	TL FİYAT TL PRICE				
<b>DTJNR/L 93°</b>	<b>Sol / Left</b>	<b>Sağ / Right</b>	<b>h</b>	<b>b</b>	<b>L</b>	<b>f</b>		
DTJNR/L - 2020 - K22	VRD1125	VRD1168	20	20	125	25	TNM.. 22 04..	₺917
DTJNR/L - 2525 - M22	VRD1127	VRD1170	25	25	150	32		₺982
DTJNR/L - 3232 - P22	VRD1129	VRD1172	32	32	170	40		₺1.145
DTJNR/L - 2020 - K16	VRD1133	VRD1176	20	20	125	25	TNM.. 16 04..	₺917
DTJNR/L - 2525 - M16	VRD1135	VRD1178	25	25	150	32		₺982
DTJNR/L - 3232 - P16	VRD1137	VRD1180	32	32	170	40		₺1.145
DTJNR/L - 4040 - S22	VRD1207	VRD1208	40	40	250	50	TNM.. 22 04..	₺2.197

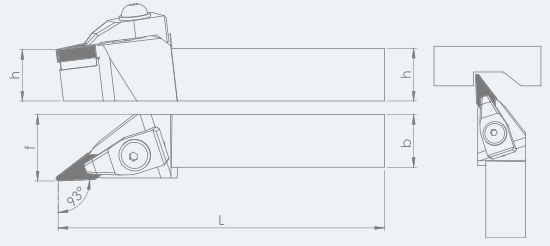
**TEKNİK ÇİZİM / TECHNICAL DRAWING**

TAKIM KODU ORDERING CODE	ÜRÜN KODU PRODUCT CODE	KATER ÖLÇÜLERİ DIMENSIONS (mm)	KESİCİ UÇ INSERT	TL FİYAT TL PRICE
-----------------------------	---------------------------	-----------------------------------	---------------------	----------------------

**DVJNR/L 93°**

Sol / Left	Sağ / Right	h	b	L	f
------------	-------------	---	---	---	---

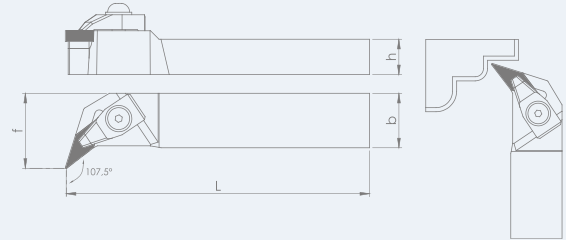

DVJNR/L - 1616 - H16	VRD1139	VRD1182	16	16	100	20
DVJNR/L - 2020 - K16	VRD1141	VRD1184	20	20	125	25
DVJNR/L - 2525 - M16	VRD1143	VRD1186	25	25	150	32
DVJNR/L - 3232 - P16	VRD1145	VRD1188	32	32	170	40

**₺917**
**VNM..  
16 04..**
**₺917**
**₺982**
**₺1.156**

**TEKNİK ÇİZİM / TECHNICAL DRAWING**

TAKIM KODU ORDERING CODE	ÜRÜN KODU PRODUCT CODE	KATER ÖLÇÜLERİ DIMENSIONS (mm)	KESİCİ UÇ INSERT	TL FİYAT TL PRICE
-----------------------------	---------------------------	-----------------------------------	---------------------	----------------------

**DVHNR /L 107,5°**

Sol / Left	Sağ / Right	h	b	L	f
------------	-------------	---	---	---	---



DVHNR/L - 2020 - K16	VRD1147	VRD1190	20	20	125	25
DVHNR/L - 2525 - M16	VRD1149	VRD1192	25	25	150	32
DVHNR/L - 3232 - P16	VRD1151	VRD1194	32	32	170	40

**₺917**
**VNM..  
16 04..**
**₺982**
**₺1.156**





[www.vorgen.com](http://www.vorgen.com)

**VORGEN®**

# M SİSTEM DIŞ TORNA KATERLERİ

M SYSTEM EXTERNAL LATHE  
TOOL HOLDERS

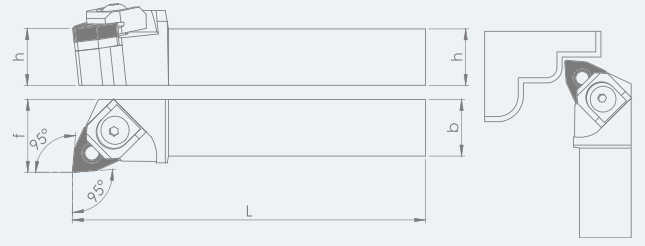

TEKNİK ÇİZİM / TECHNICAL DRAWING

TAKIM KODU ORDERING CODE	ÜRÜN KODU PRODUCT CODE	KATER ÖLÇÜLERİ DIMENSIONS (mm)	KESİCİ UÇ INSERT	TL FİYAT TL PRICE
-----------------------------	---------------------------	-----------------------------------	---------------------	----------------------

**MWLNR/L 95°**

Sol / Left	Sağ / Right	h	b	L	f
------------	-------------	---	---	---	---



MWLNR/L - 2020 - K08	VRM1153	VRM1196	20	20	125	25	₺917
MWLNR/L - 2525 - M08	VRM1155	VRM1198	25	25	150	32	₺982
MWLNR/L - 3232 - P08	VRM1157	VRM1200	32	32	170	40	₺1.156
MWLNR/L - 4040 - S08	VRM1159	VRM1202	40	40	250	50	₺1.944
MWLNR/L - 2020 - K06	VRM1161	VRM1204	20	20	125	25	₺917
MWLNR/L - 2525 - M06	VRM1163	VRM1206	25	25	150	32	₺982

**WNM..  
08 04..**

**WNM..  
06 T3..**

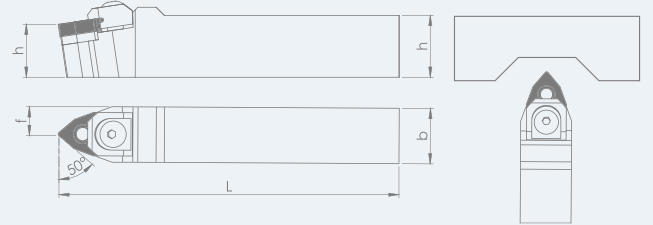

TEKNİK ÇİZİM / TECHNICAL DRAWING

TAKIM KODU ORDERING CODE	ÜRÜN KODU PRODUCT CODE	KATER ÖLÇÜLERİ DIMENSIONS (mm)	KESİCİ UÇ INSERT	TL FİYAT TL PRICE
-----------------------------	---------------------------	-----------------------------------	---------------------	----------------------

**MWENN 50°**

h	b	L	f
---	---	---	---



MWENN - 2020 - K08	VRN1208		20	20	125	10	₺917
MWENN - 2525 - M08	VRN1210		25	25	150	12,5	₺982
MWENN - 3232 - P08	VRN1212		32	32	170	16	₺1.156
MWENN - 2020 - K06	VRN1214		20	20	125	10	₺917
MWENN - 2525 - M06	VRN1216		25	25	150	12,5	₺982

**WNM..  
08 04..**

**WNM..  
06 T3..**

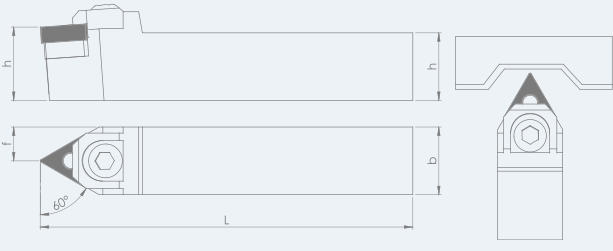

TEKNİK ÇİZİM / TECHNICAL DRAWING

TAKIM KODU ORDERING CODE	ÜRÜN KODU PRODUCT CODE	KATER ÖLÇÜLERİ DIMENSIONS (mm)	KESİCİ UÇ INSERT	TL FİYAT TL PRICE
<b>MTENN 60°</b>		<b>h b L f</b>		
MTENN - 2020 - K16	VRN1218	20 20 125 10	TNM.. 16 04..	₺917
MTENN - 2525 - M16	VRN1220	25 25 150 12,5		₺982
MTENN - 3232 - P16	VRN1222	32 32 170 16		₺1.156
MTENN - 2525 - M22	VRN1224	25 25 150 12,5	TNM.. 22 04..	₺982
MTENN - 3232 - P22	VRN1226	32 32 170 16		₺1.156



TEKNİK ÇİZİM / TECHNICAL DRAWING

TAKIM KODU ORDERING CODE	ÜRÜN KODU PRODUCT CODE	KATER ÖLÇÜLERİ DIMENSIONS (mm)	KESİCİ UÇ INSERT	TL FİYAT TL PRICE
<b>MTJNR/L 93°</b>		<b>Sol / Left Sağ / Right h b L f</b>		
MTJNR/L - 2020 - K16	VRM1165 VRM1228	20 20 125 25	TNM.. 16 04..	₺917
MTJNR/L - 2525 - M16	VRM1167 VRM1230	25 25 150 32		₺982
MTJNR/L - 3232 - P16	VRM1169 VRM1232	32 32 170 40		₺1.156
MTJNR/L - 4040 - S16	VRM1241 VRM1242	40 40 250 50		₺2.197
MTJNR/L - 2020 - K22	VRM1171 VRM1234	20 20 125 25	TNM.. 22 04..	₺917
MTJNR/L - 2525 - M22	VRM1173 VRM1236	25 25 150 32		₺982
MTJNR/L - 3232 - P22	VRM1175 VRM1238	32 32 170 40		₺1.156
MTJNR/L - 4040 - S22	VRM1177 VRM1240	40 40 250 50		₺2.197



[www.vorgen.com](http://www.vorgen.com)

**VORGEN®**

## **C SİSTEM DIŞ TORNA KATERLERİ**

**C SYSTEM EXTERNAL LATHE  
TOOL HOLDERS**



TEKNİK ÇİZİM / TECHNICAL DRAWING



TAKIM KODU ORDERING CODE	ÜRÜN KODU PRODUCT CODE	KATER ÖLÇÜLERİ DIMENSIONS (mm)	KESİCİ UÇ INSERT	TL FİYAT TL PRICE
-----------------------------	---------------------------	-----------------------------------	---------------------	----------------------

**CKJNR/L 93°**

Sol / Left	Sağ / Right	h	b	L	f			
CKJNR/L - 2020 - K16	VRC1179	VRC1242	20	20	125	25		₺777
CKJNR/L - 2525 - M16	VRC1181	VRC1244	25	25	150	32	KNUX16 R/L	₺818
CKJNR/L - 3232 - P16	VRC1183	VRC1246	32	32	170	40		₺1.121
CKJNR/L - 4040 - S16	VRC1185	VRC1248	40	40	250	50		₺1.944



TEKNİK ÇİZİM / TECHNICAL DRAWING



TAKIM KODU ORDERING CODE	ÜRÜN KODU PRODUCT CODE	KATER ÖLÇÜLERİ DIMENSIONS (mm)	KESİCİ UÇ INSERT	TL FİYAT TL PRICE
-----------------------------	---------------------------	-----------------------------------	---------------------	----------------------

**CTGPR/L 90°**

Sol / Left	Sağ / Right	h	b	L	f			
CTGPR/L - 2020 - K16	VRC1191	VRC1254	20	20	125	25		₺818
CTGPR/L - 2525 - M16	VRC1193	VRC1256	25	25	150	32	TP 1603..	₺878
CTGPR/L - 3232 - P16	VRC1277	VRC1278	32	32	170	40		₺1.156
CTGPR/L - 2525 - M22	VRC1195	VRC1258	25	25	150	32	TP 2204..	₺878
CTGPR/L - 3232 - P22	VRC1197	VRC1260	32	32	170	40		₺1.026



TEKNİK ÇİZİM / TECHNICAL DRAWING

TAKIM KODU ORDERING CODE	ÜRÜN KODU PRODUCT CODE	KATER ÖLÇÜLERİ DIMENSIONS (mm)	KESİCİ UÇ INSERT	TL FİYAT TL PRICE
-----------------------------	---------------------------	-----------------------------------	---------------------	----------------------

**CSDNN 45°**

h	b	L	f
25	25	150	12,5
32	32	170	16



SNM..	₺1.095
12 07..	₺1.112

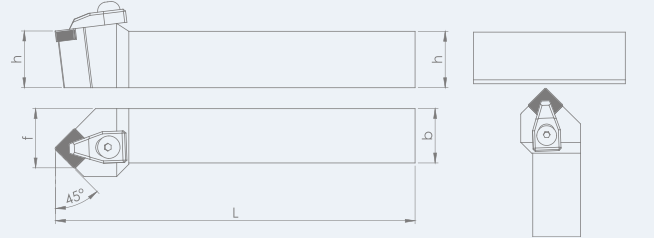

TEKNİK ÇİZİM / TECHNICAL DRAWING

TAKIM KODU ORDERING CODE	ÜRÜN KODU PRODUCT CODE	KATER ÖLÇÜLERİ DIMENSIONS (mm)	KESİCİ UÇ INSERT	TL FİYAT TL PRICE
-----------------------------	---------------------------	-----------------------------------	---------------------	----------------------

**CSSNR 45°**

h	b	L	f
25	25	150	12,5
32	32	170	16



SNM..	₺1.095
12 07..	₺1.112



TEKNİK ÇİZİM / TECHNICAL DRAWING



TAKIM KODU ORDERING CODE	ÜRÜN KODU PRODUCT CODE	KATER ÖLÇÜLERİ DIMENSIONS (mm)	KESİCİ UÇ INSERT	TL FİYAT TL PRICE
-----------------------------	---------------------------	-----------------------------------	---------------------	----------------------

**CDJNR/L 93°**

Sol / Left	Sağ / Right	h	b	L	f
------------	-------------	---	---	---	---



CDJNR/L - 2525 - M15

VRC1199

VRC1270

25

25

150

32

DNM..  
15 07..

₺1.095

CDJNR/L - 3232 - P15

VRC1201

VRC1272

32

32

170

40

₺1.112



TEKNİK ÇİZİM / TECHNICAL DRAWING



TAKIM KODU ORDERING CODE	ÜRÜN KODU PRODUCT CODE	KATER ÖLÇÜLERİ DIMENSIONS (mm)	KESİCİ UÇ INSERT	TL FİYAT TL PRICE
-----------------------------	---------------------------	-----------------------------------	---------------------	----------------------

**CCLNR/L 95°**

Sol / Left	Sağ / Right	h	b	L	f
------------	-------------	---	---	---	---



CCLNR/L - 2525 - M12

VRC1273

VRC1274

25

25

150

32

CNM..  
12 07..

₺1.095

CCLNR/L - 3232 - P12

VRC1275

VRC1276

32

32

170

40

₺1.112

[www.vorgen.com](http://www.vorgen.com)



---

# **S SİSTEM DIŐ TORNA KATERLERİ**

**S SYSTEM EXTERNAL LATHE  
TOOL HOLDERS**





VORGEN®  
SRDCN 2525 M10



PRIMO M10



VORGEN



VORGEN



VORGEN®  
SVJBR 2020 K16



VORGEN



VORGEN

400267



VORGEN®  
STTCM



TEKNİK ÇİZİM / TECHNICAL DRAWING

TAKIM KODU ORDERING CODE	ÜRÜN KODU PRODUCT CODE	KATER ÖLÇÜLERİ DIMENSIONS (mm)	KESİCİ UÇ INSERT	TL FİYAT TL PRICE
-----------------------------	---------------------------	-----------------------------------	---------------------	----------------------

**SRHCR/L 20°**

Sol / Left	Sağ / Right	h	b	L	f
------------	-------------	---	---	---	---



SRHCR/L - 2525 - K10	VRS1203	VRS1274	25	25	125	25	RC.. 10	₺1.443
----------------------	---------	---------	----	----	-----	----	---------	--------

SRHCR/L - 2525 - K12	VRS1205	VRS1276	25	25	125	25	RC.. 12	₺1.443
----------------------	---------	---------	----	----	-----	----	---------	--------



TEKNİK ÇİZİM / TECHNICAL DRAWING

TAKIM KODU ORDERING CODE	ÜRÜN KODU PRODUCT CODE	KATER ÖLÇÜLERİ DIMENSIONS (mm)	KESİCİ UÇ INSERT	TL FİYAT TL PRICE
-----------------------------	---------------------------	-----------------------------------	---------------------	----------------------

**STTCN 90°**

L1	h	b	L	f
----	---	---	---	---



STTCN - 2525 - P11	VRS1278	65	25	25	170	12,5	TC.. 11 02..	₺1.009
--------------------	---------	----	----	----	-----	------	--------------	--------

STTCN - 2525 - P16	VRN1280	65	25	25	170	12,5	TC.. 16 T3..	₺1.009
--------------------	---------	----	----	----	-----	------	--------------	--------

STTCN - 3232 - P16	VRN1282	70	32	32	170	16	TC.. 22 04..	₺1.170
--------------------	---------	----	----	----	-----	----	--------------	--------

STTCN - 3232 - P22	VRN1284	70	32	32	170	16	TC.. 22 04..	₺1.170
--------------------	---------	----	----	----	-----	----	--------------	--------



TEKNİK ÇİZİM / TECHNICAL DRAWING

TAKIM KODU  
ORDERING CODEÜRÜN KODU  
PRODUCT CODEKATER ÖLÇÜLERİ  
DIMENSIONS (mm)KESİCİ UÇ  
INSERTTL FİYAT  
TL PRICE**STJCR/L 93°**

Sol / Left

Sağ / Right

h

b

L

f



STJCR/L - 1616 - H16

VRS1207

VRS1286

16

16

100

20

₺715

STJCR/L - 2020 - K16

VRS1209

VRS1288

20

20

125

25

₺738

STJCR/L - 2525 - M16

VRS1211

VRS1290

25

25

150

32

₺767

STJCR/L - 3232 - P16

VRS1213

VRS1292

32

32

170

40

₺924

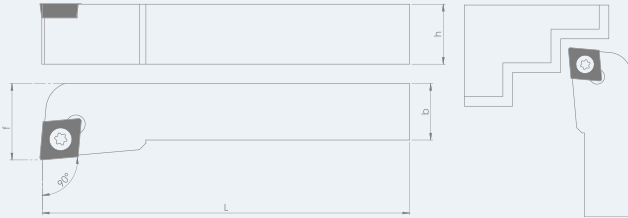
TC.. 16  
T3..

TEKNİK ÇİZİM / TECHNICAL DRAWING

TAKIM KODU  
ORDERING CODEÜRÜN KODU  
PRODUCT CODEKATER ÖLÇÜLERİ  
DIMENSIONS (mm)KESİCİ UÇ  
INSERTTL FİYAT  
TL PRICE**SCACR/L 90°**

Sol / Left

Sağ / Right

h

b

L

f



SCACR/L - 1212 - F09

VRS1215

VRS1294

12

12

80

16

₺602

SCACR/L - 1616 - H09

VRS1217

VRS1296

16

16

100

20

₺715

SCACR/L - 2020 - K09

VRS1219

VRS1298

20

20

125

25

₺738

SCACR/L - 2525 - M09

VRS1221

VRS1300

25

25

150

32

₺772

SCACR/L - 2020 - K12

VRS1223

VRS1302

20

20

125

25

₺738

SCACR/L - 2525 - M12

VRS1225

VRS1304

25

25

150

32

₺790

CCM.. 09  
T3..CCM.. 12  
04..

**TEKNİK ÇİZİM / TECHNICAL DRAWING**

TAKIM KODU ORDERING CODE	ÜRÜN KODU PRODUCT CODE	KATER ÖLÇÜLERİ DIMENSIONS (mm)	KESİCİ UÇ INSERT	TL FİYAT TL PRICE
<b>SSDCN</b>	<b>45°</b>	<b>h</b> <b>b</b> <b>L</b> <b>f</b>		
SSDCN - 2020 - K09	VRN1498	20 20 125 10	<b>SC. T 09 T3..</b>	₺738
SSDCN - 2525 - M09	VRN1299	25 25 159 12,5		₺772
SSDCN - 2020 - K12	VRN1306	20 20 125 10	<b>SC. T 12 04..</b>	₺738
SSDCN - 2525 - M12	VRN1308	25 25 150 12,5		₺790

**TEKNİK ÇİZİM / TECHNICAL DRAWING**

TAKIM KODU ORDERING CODE	ÜRÜN KODU PRODUCT CODE	KATER ÖLÇÜLERİ DIMENSIONS (mm)	KESİCİ UÇ INSERT	TL FİYAT TL PRICE
<b>SDJCR/L</b>	<b>93°</b>	<b>Sol / Left</b> <b>Sağ / Right</b> <b>h</b> <b>b</b> <b>L</b> <b>f</b>		
SDJCR/L - 0808 - F07	VRS1227	VRS1310	<b>DCM.. 07 T3..</b>	₺590
SDJCR/L - 1010 - F07	VRS1229	VRS1312		₺595
SDJCR/L - 1212 - F07	VRS1231	VRS1314		₺602
SDJCR/L - 1212 - F11	VRS1233	VRS1316	<b>DCM.. 11 T3..</b>	₺602
SDJCR/L - 1616 - H11	VRS1235	VRS1318		₺715
SDJCR/L - 2020 - K11	VRS1237	VRS1320		₺738
SDJCR/L - 2525 - M11	VRS1239	VRS1322		₺772
SDJCR/L - 3232 - P11	VRS1241	VRS1324		₺935



TEKNİK ÇİZİM / TECHNICAL DRAWING

TAKIM KODU  
ORDERING CODEÜRÜN KODU  
PRODUCT CODEKATER ÖLÇÜLERİ  
DIMENSIONS (mm)KESİCİ UÇ  
INSERTTL FİYAT  
TL PRICE**SDHCR/L 107,5°**

Sol / Left

Sağ / Right

h

b

L

f



SDHCR/L - 2020 - K11

VRS1243

VRS1326

20

20

125

25

DCM..  
11 T3..

₺738

SDHCR/L - 2525 - M11

VRS1245

VRS1328

25

25

150

32

₺772



TEKNİK ÇİZİM / TECHNICAL DRAWING

TAKIM KODU  
ORDERING CODEÜRÜN KODU  
PRODUCT CODEKATER ÖLÇÜLERİ  
DIMENSIONS (mm)KESİCİ UÇ  
INSERTTL FİYAT  
TL PRICE**STGCR/L 90°**

Sol / Left

Sağ / Right

h

b

L

f



STGCR/L - 1616 - H16

VRS1247

VRS1330

16

16

100

20

₺715

STGCR/L - 2020 - K16

VRS1249

VRS1332

20

20

125

25

TC..  
16 T3..

₺738

STGCR/L - 2525 - M16

VRS1251

VRS1334

25

25

150

32

₺772

STGCR/L - 3232 - P16

VRS1253

VRS1336

32

32

170

40

₺935

**TEKNİK ÇİZİM / TECHNICAL DRAWING**

TAKIM KODU ORDERING CODE	ÜRÜN KODU PRODUCT CODE	KATER ÖLÇÜLERİ DIMENSIONS (mm)	KESİCİ UÇ INSERT	TL FİYAT TL PRICE
-----------------------------	---------------------------	-----------------------------------	---------------------	----------------------

**SDNCN 62,5°**

h	b	L	f
---	---	---	---



SDNCN - 1212 - F07	VRN1338	12	12	80	6
SDNCN - 1212 - F11	VRN1340	12	12	80	6
SDNCN - 1616 - H11	VRN1342	16	16	100	8
SDNCN - 2020 - K11	VRN1344	20	20	125	10
SDNCN - 2525 - M11	VRN1346	25	25	150	12,5
SDNCN - 3232 - P11	VRN1348	32	32	170	16

**DCM..  
07 T3..**
**₺602**
**₺602**
**₺715**
**DCM..  
11 T3..**
**₺738**
**₺772**
**₺926**

**TEKNİK ÇİZİM / TECHNICAL DRAWING**

TAKIM KODU ORDERING CODE	ÜRÜN KODU PRODUCT CODE	KATER ÖLÇÜLERİ DIMENSIONS (mm)	KESİCİ UÇ INSERT	TL FİYAT TL PRICE
-----------------------------	---------------------------	-----------------------------------	---------------------	----------------------

**SVJBR/L 93°**

Sol / Left	Sağ / Right	h	b	L	f
------------	-------------	---	---	---	---



SVJBR/L - 1212 - F11	VRS1255	VRS1350	12	12	80	16
SVJBR/L - 1616 - H11	VRS1257	VRS1352	16	16	100	20
SVJBR/L - 2020 - K11	VRS1259	VRS1354	20	20	125	25
SVJBR/L - 1616 - H16	VRS1521	VRS1522	16	16	100	20
SVJBR/L - 2020 - K16	VRS1261	VRS1356	20	20	125	25
SVJBR/L - 2525 - M16	VRS1263	VRS1358	25	25	150	32
SVJBR/L - 3232 - P16	VRS1265	VRS1360	32	32	170	40

**VBM..  
11 03..**
**₺655**
**₺715**
**₺738**
**₺715**
**₺738**
**VBM..  
16 04..**
**₺772**
**₺926**



## TEKNİK ÇİZİM / TECHNICAL DRAWING

TAKIM KODU ORDERING CODE	ÜRÜN KODU PRODUCT CODE	KATER ÖLÇÜLERİ DIMENSIONS (mm)	KESİCİ UÇ INSERT	TL FİYAT TL PRICE
<b>SVVBN</b> 72,5°		<b>h</b> <b>b</b> <b>L</b> <b>f</b>		
SVVBN - 1212 - F11	VRN1362	12 12 80 6		₺655
SVVBN - 1616 - H11	VRN1364	16 16 100 8	<b>VBM.. 11 03..</b>	₺715
SVVBN - 2020 - K11	VRN1366	20 20 125 10		₺738
SVVBN - 1616 - H16	VRN1500	16 16 100 8		₺715
SVVBN - 2020 - K16	VRN1368	20 20 125 10	<b>VBM.. 16 04..</b>	₺738
SVVBN - 2525 - M16	VRN1370	25 25 150 12,5		₺772
SVVBN - 3232 - P16	VRN1372	32 32 170 16		₺926



## TEKNİK ÇİZİM / TECHNICAL DRAWING

TAKIM KODU ORDERING CODE	ÜRÜN KODU PRODUCT CODE	KATER ÖLÇÜLERİ DIMENSIONS (mm)	KESİCİ UÇ INSERT	TL FİYAT TL PRICE
<b>SVHBR/L</b> 107,5°		<b>h</b> <b>b</b> <b>L</b> <b>f</b>		
SVHBR/L - 1212 - F11	VRS1267	VRS1374 12 12 80 16		₺655
SVHBR/L - 1616 - H11	VRS1269	VRS1376 16 16 100 20	<b>VBM.. 11 03..</b>	₺715
SVHBR/L - 2020 - K11	VRS1271	VRS1378 20 20 125 25		₺738
SVHBR/L - 2020 - K16	VRS1275	VRS1382 20 20 125 25		₺738
SVHBR/L - 2525 - M16	VRS1277	VRS1384 25 25 150 32	<b>VBM.. 16 04..</b>	₺772
SVHBR/L - 3232 - P16	VRS1279	VRS1386 32 25 170 40		₺926

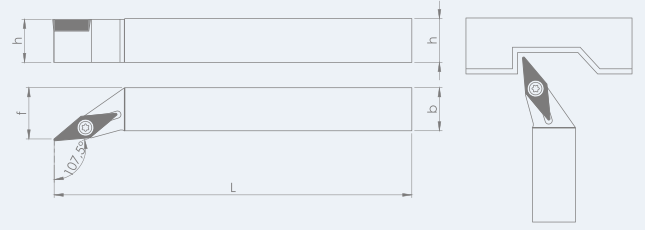
**TEKNİK ÇİZİM / TECHNICAL DRAWING**

TAKIM KODU ORDERING CODE	ÜRÜN KODU PRODUCT CODE	KATER ÖLÇÜLERİ DIMENSIONS (mm)	KESİCİ UÇ INSERT	TL FİYAT TL PRICE
-----------------------------	---------------------------	-----------------------------------	---------------------	----------------------

**SVHCR/L 107,5°**

Sol / Left	Sağ / Right	h	b	L	f
------------	-------------	---	---	---	---



SVHCR/L - 1212 - F11	VRS1281	VRS1388	12	12	80	16
SVHCR/L - 1616 - H11	VRS1283	VRS1390	16	16	100	20
SVHCR/L - 2020 - K11	VRS1285	VRS1392	20	20	125	25
SVHCR/L - 2020 - K16	VRS1287	VRS1394	20	20	125	25
SVHCR/L - 2525 - M16	VRS1289	VRS1396	25	25	150	32
SVHCR/L - 3232 - P16	VRS1291	VRS1398	32	25	170	40

**VCM..  
11 03..**
**₺655**
**₺715**
**₺738**
**VCM..  
16 04..**
**₺738**
**₺772**
**₺926**

**TEKNİK ÇİZİM / TECHNICAL DRAWING**

TAKIM KODU ORDERING CODE	ÜRÜN KODU PRODUCT CODE	KATER ÖLÇÜLERİ DIMENSIONS (mm)	KESİCİ UÇ INSERT	TL FİYAT TL PRICE
-----------------------------	---------------------------	-----------------------------------	---------------------	----------------------

**SVJCR/L 93°**

Sol / Left	Sağ / Right	h	b	L	f
------------	-------------	---	---	---	---



SVJCR/L - 1212 - F11	VRS1293	VRS1400	12	12	80	16
SVJCR/L - 1616 - H11	VRS1295	VRS1402	16	16	100	20
SVJCR/L - 2020 - K11	VRS1297	VRS1404	20	20	125	25
SVLCR/L - 1616 - H16	VRS1523	VRS1524	16	16	100	20
SVJCR/L - 2020 - K16	VRS1299	VRS1406	20	20	125	25
SVJCR/L - 2525 - M16	VRS1301	VRS1408	25	25	150	32
SVJCR/L - 3232 - P16	VRS1303	VRS1410	32	32	170	40

**VCM..  
11 03..**
**₺655**
**₺715**
**₺738**
**VCM..  
16 04..**
**₺715**
**₺738**
**₺772**
**₺926**



**TEKNİK ÇİZİM / TECHNICAL DRAWING**

TAKIM KODU ORDERING CODE	ÜRÜN KODU PRODUCT CODE	KATER ÖLÇÜLERİ DIMENSIONS (mm)	KESİCİ UÇ INSERT	TL FİYAT TL PRICE
<b>SVVCN</b>	<b>72,5°</b>	<b>h</b> <b>b</b> <b>L</b> <b>f</b>		
SVVCN - 1212 - F11	VRN1412	12 12 80 6	VCM.. 11 03..	₺655
SVVCN - 1616 - H11	VRN1414	16 16 100 8		₺715
SVVCN - 2020 - K11	VRN1416	20 20 125 10		₺738
SVVCN - 1616 - H16	VRN1501	16 16 100 8	VCM.. 16 04..	₺715
SVVCN - 2020 - K16	VRN1420	20 20 125 10		₺738
SVVCN - 2525 - M16	VRN1422	25 25 150 12,5		₺772
SVVCN - 3232 - P16	VRN1424	32 25 170 16		₺926

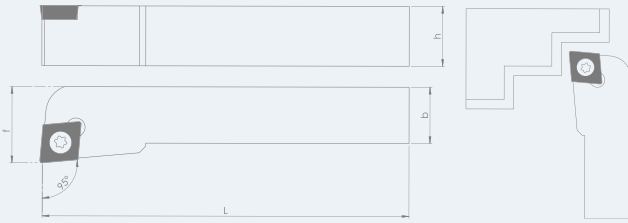
**TEKNİK ÇİZİM / TECHNICAL DRAWING**

TAKIM KODU ORDERING CODE	ÜRÜN KODU PRODUCT CODE	KATER ÖLÇÜLERİ DIMENSIONS (mm)	KESİCİ UÇ INSERT	TL FİYAT TL PRICE
<b>SCLCR/L</b>	<b>95°</b>	<b>Sol / Left</b> <b>Sağ / Right</b> <b>h</b> <b>b</b> <b>L</b> <b>f</b>		
SCLCR/L - 0808 - F06	VRS1305	VRS1426 08 08 80 10	CCM.. 06 02..	₺590
SCLCR/L - 1010 - F06	VRS1307	VRS1428 10 10 80 12		₺595
SCLCR/L - 1212 - F06	VRS1309	VRS1430 12 12 80 16		₺655
SCLCR/L - 1212 - F09	VRS1311	VRS1432 12 12 80 16	CCM.. 09 T3..	₺655
SCLCR/L - 1616 - H09	VRS1313	VRS1434 16 16 100 20		₺715
SCLCR/L - 2020 - K09	VRS1315	VRS1436 20 20 125 25		₺738
SCLCR/L - 2525 - M09	VRS1317	VRS1438 25 25 150 32		₺772
SCLCR/L - 2020 - K12	VRS1319	VRS1440 20 20 125 25	CCM.. 12 04..	₺738
SCLCR/L - 2525 - M12	VRS1321	VRS1442 25 25 150 32		₺772

**TEKNİK ÇİZİM / TECHNICAL DRAWING**

TAKIM KODU ORDERING CODE	ÜRÜN KODU PRODUCT CODE	KATER ÖLÇÜLERİ DIMENSIONS (mm)	KESİCİ UÇ INSERT	TL FİYAT TL PRICE
-----------------------------	---------------------------	-----------------------------------	---------------------	----------------------

SRDCN	90°	KATER ÖLÇÜLERİ DIMENSIONS (mm)				KESİCİ UÇ INSERT	TL FİYAT TL PRICE
		h	b	L	f		
SRDCN - 2020 - K06	VRN1444	20	20	125	10	RC.. 06	₺738
SRDCN - 2525 - M06	VRN1446	25	25	150	12,5	RC.. 06	₺772
SRDCN - 2020 - K08	VRN1448	20	20	125	10	RC.. 08	₺738
SRDCN - 2525 - M08	VRN1450	25	25	150	12,5	RC.. 08	₺772
SRDCN - 3232 - P08	VRN1452	32	32	170	16	RC.. 08	₺926
SRDCN - 2020 - K10	VRN1454	20	20	125	10	RC.. 10	₺738
SRDCN - 2525 - M10	VRN1456	25	25	150	12,5	RC.. 10	₺772
SRDCN - 3232 - P10	VRN1458	32	32	170	16	RC.. 10	₺926
SRDCN - 2020 - K12	VRN1460	20	20	125	10	RC.. 12	₺738
SRDCN - 2525 - M12	VRN1462	25	25	150	12,5	RC.. 12	₺772
SRDCN - 3232 - P12	VRN1464	32	32	170	16	RC.. 12	₺926
SRDCN - 2020 - K16	VRN1466	20	20	125	10	RC.. 16	₺738
SRDCN - 2525 - M16	VRN1468	25	25	150	12,5	RC.. 16	₺772
SRDCN - 3232 - P16	VRN1470	32	32	170	16	RC.. 16	₺926
SRDCN - 4040 - S16	VRN1502	40	40	250	50	RC.. 16	₺2.197
SRDCN - 2525 - M20	VRN1472	25	25	150	12,5	RC.. 20	₺772
SRDCN - 3232 - P20	VRN1474	32	32	170	16	RC.. 20	₺926
SRDCN - 4040 - S20	VRN1476	40	40	250	50	RC.. 20	₺2.197

**TEKNİK ÇİZİM / TECHNICAL DRAWING**

TAKIM KODU ORDERING CODE	ÜRÜN KODU PRODUCT CODE	KATER ÖLÇÜLERİ DIMENSIONS (mm)	KESİCİ UÇ INSERT	TL FİYAT TL PRICE
-----------------------------	---------------------------	-----------------------------------	---------------------	----------------------

SSSCR/L	45°	KATER ÖLÇÜLERİ DIMENSIONS (mm)				KESİCİ UÇ INSERT	TL FİYAT TL PRICE		
		Sol / Left	Sağ / Right	h	b			L	f
SSSCR/L - 2020 - K12	VRN1444	VRS1323	VRS1478	20	20	125	25	SC. T..	₺738
SSSCR/L - 2525 - M12	VRN1446	VRS1325	VRS1480	25	25	150	32	12 04..	₺772



## TEKNİK ÇİZİM / TECHNICAL DRAWING

TAKIM KODU ORDERING CODE	ÜRÜN KODU PRODUCT CODE	KATER ÖLÇÜLERİ DIMENSIONS (mm)	KESİCİ UÇ INSERT	TL FİYAT TL PRICE
<b>SCMCN 50°</b>		<b>h</b> <b>b</b> <b>L</b> <b>f</b>		
SCMCN - 1212 - F09	VRN1482	12 12 80 06		₺655
SCMCN - 1616 - H09	VRN1484	16 16 100 08	<b>CCM..</b>	₺715
SCMCN - 2020 - K09	VRN1486	20 20 125 10	<b>09 T3..</b>	₺738
SCMCN - 2525 - M09	VRN1488	25 25 150 12,5		₺772
SCMCN - 2020 - K12	VRN1490	20 20 125 10	<b>CCM..</b>	₺738
SCMCN - 2525 - M12	VRN1492	25 25 150 12,5	<b>12 04..</b>	₺772

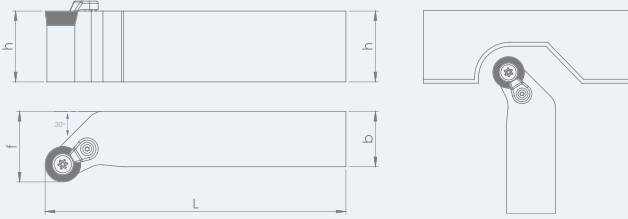

## TEKNİK ÇİZİM / TECHNICAL DRAWING

TAKIM KODU ORDERING CODE	ÜRÜN KODU PRODUCT CODE	KATER ÖLÇÜLERİ DIMENSIONS (mm)	KESİCİ UÇ INSERT	TL FİYAT TL PRICE
<b>SRGCR/L 30°</b>		<b>Sol / Left</b> <b>Sağ / Right</b> <b>h</b> <b>b</b> <b>L</b> <b>f</b>		
SRGCR/L - 2020 - K06	VRS1327	VRS1494 20 20 125 25	<b>RC.. 06</b>	₺715
SRGCR/L - 2525 - M06	VRS1329	VRS1496 25 25 150 32		₺738
SRGCR/L - 2020 - K08	VRS1331	VRS1498 20 20 125 25	<b>RC.. 08</b>	₺715
SRGCR/L - 2525 - M08	VRS1333	VRS1500 25 25 150 32		₺738
SRGCR/L - 2020 - K10	VRS1337	VRS1504 20 20 125 25		₺715
SRGCR/L - 2525 - M10	VRS1339	VRS1506 25 25 150 32	<b>RC.. 10</b>	₺738
SRGCR/L - 3232 - P10	VRS1341	VRS1508 32 32 170 16		₺871
SRGCR/L - 2020 - K12	VRS1343	VRS1510 20 20 125 25		₺715
SRGCR/L - 2525 - M12	VRS1345	VRS1512 25 25 150 32	<b>RC.. 12</b>	₺738
SRGCR/L - 3232 - P12	VRS1347	VRS1514 32 32 170 16		₺871
SRGCR/L - 2020 - K16	VRS1349	VRS1516 20 20 125 25		₺715
SRGCR/L - 2525 - M16	VRS1351	VRS1518 25 25 150 32	<b>RC.. 16</b>	₺738
SRGCR/L - 3232 - P16	VRS1353	VRS1520 32 32 170 16		₺871
SRGCR/L - 3232 - P20	VRS1503	VRS1504 32 32 170 16	<b>RC.. 20</b>	₺871

www.vorgen.com

**VORGEN**<sup>®</sup>

## **P SİSTEM DIŞ TORNA KATERLERİ**

P SYSTEM EXTERNAL LATHE  
TOOL HOLDERS

## **TIRTIR TORNA KATERLERİ**

INCHINEMUON CLAMP  
OUTSIDE DIAMETER





TEKNİK ÇİZİM / TECHNICAL DRAWING

TAKIM KODU ORDERING CODE	ÜRÜN KODU PRODUCT CODE	KATER ÖLÇÜLERİ DIMENSIONS (mm)	KESİCİ UÇ INSERT	TL FİYAT TL PRICE				
<b>PTJNR/L 93°</b>	<b>Sol / Left</b>	<b>Sağ / Right</b>	<b>h</b>	<b>b</b>	<b>L</b>	<b>f</b>		
PTJNR/L - 2020 - K22	VRP1361	VRP1532	20	20	125	25	TNM.. 22 04..	₺1.001
PTJNR/L - 2525 - M22	VRP1363	VRP1534	25	25	150	32		₺1.026
PTJNR/L - 3232 - P22	VRP1365	VRP1536	32	32	170	40		₺1.091
PTJNR/L - 4040 - S22	VRP1367	VRP1538	40	40	200	50		₺1.232
PTJNR/L - 2020 - K16	VRP1369	VRP1540	20	20	125	25	TNM.. 16 04..	₺1.001
PTJNR/L - 2525 - M16	VRP1371	VRP1542	25	25	150	32		₺1.026
PTJNR/L - 3232 - P16	VRP1373	VRP1544	32	32	170	40		₺1.091



TEKNİK ÇİZİM / TECHNICAL DRAWING

TAKIM KODU ORDERING CODE	ÜRÜN KODU PRODUCT CODE	KATER ÖLÇÜLERİ DIMENSIONS (mm)	KESİCİ UÇ INSERT	TL FİYAT TL PRICE				
<b>PCLNR/L 95°</b>	<b>Sol / Left</b>	<b>Sağ / Right</b>	<b>h</b>	<b>b</b>	<b>L</b>	<b>f</b>		
PCLNR/L - 2020 - K12	VRP1375	VRP1546	20	20	125	25	CNM.. 12 04..	₺1.001
PCLNR/L - 2525 - M12	VRP1377	VRP1548	25	25	150	32		₺1.026
PCLNR/L - 3232 - P12	VRP1379	VRP1550	32	32	170	40		₺1.091
PCLNR/L - 4040 - S12	VRP1381	VRP1552	40	40	250	50		₺1.232

**TEKNİK ÇİZİM / TECHNICAL DRAWING****TAKIM KODU**  
ORDERING CODE**ÜRÜN KODU**  
PRODUCT CODE**KATER ÖLÇÜLERİ**  
DIMENSIONS (mm)**KESİCİ UÇ**  
INSERT**TL FİYAT**  
TL PRICE**TIRTIR**

TKCN - 25 25 2

VRN1505

25 25 150 44

**20 x 10 x 16****₺926**

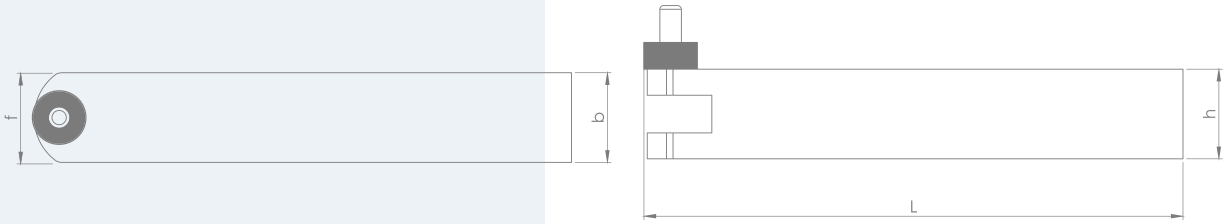

TEKNİK ÇİZİM / TECHNICAL DRAWING

TAKIM KODU  
ORDERING CODEÜRÜN KODU  
PRODUCT CODEKATER ÖLÇÜLERİ  
DIMENSIONS (mm)KESİCİ UÇ  
INSERTTL FİYAT  
TL PRICE**TIRTIR**

TKTN - 25 25 1

VRN1506

25 25 150 25

20 x 10 x 16

₺632

h b L f









[www.vorgen.com](http://www.vorgen.com)  **VORGEN®**

---

# **D SİSTEM DELİK TORNA KATERLERİ**

**D SYSTEM BORING BARS**

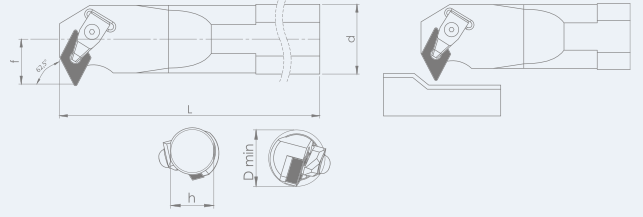
**TEKNİK ÇİZİM / TECHNICAL DRAWING**

TAKIM KODU ORDERING CODE	ÜRÜN KODU PRODUCT CODE	KATER ÖLÇÜLERİ DIMENSIONS (mm)	KESİCİ UÇ INSERT	TL FİYAT TL PRICE
-----------------------------	---------------------------	-----------------------------------	---------------------	----------------------

**DD-NR/L 62,5°**

Sol Left	Sağ Right	d	h	L	f	Dmin
-------------	--------------	---	---	---	---	------

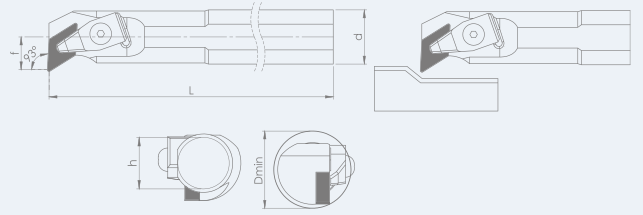

S32T - DD-NR/L - 15	VRI1383	VRI1558	32	30	300	22	44
S40U - DD-NR/L - 15	VRI1385	VRI1560	40	37,5	350	29	52
S50V - DD-NR/L - 15	VRI1387	VRI1562	50	47	420	36	67

**₺1.346**
**DNM..  
15 06..**
**₺2.113**
**₺2.552**

**TEKNİK ÇİZİM / TECHNICAL DRAWING**

TAKIM KODU ORDERING CODE	ÜRÜN KODU PRODUCT CODE	KATER ÖLÇÜLERİ DIMENSIONS (mm)	KESİCİ UÇ INSERT	TL FİYAT TL PRICE
-----------------------------	---------------------------	-----------------------------------	---------------------	----------------------

**DDUNR/L 93°**

Sol Left	Sağ Right	d	h	L	f	Dmin
-------------	--------------	---	---	---	---	------



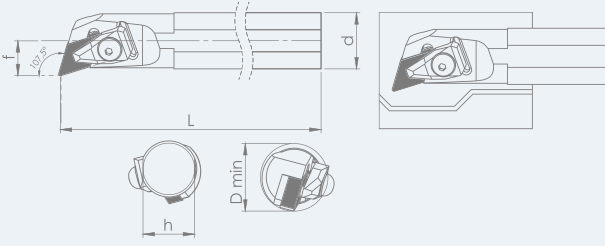

S20R - DDUNR/L - 11	VRI1389	VRI1564	20	18	200	13	25
S25S - DDUNR/L - 11	VRI1391	VRI1566	25	23	250	17	32
S25S - DDUNR/L - 15	VRI1393	VRI1568	25	23	250	17	32
S32T - DDUNR/L - 15	VRI1395	VRI1570	32	30	300	22	40
S40U - DDUNR/L - 15	VRI1397	VRI1572	40	37,5	350	27	50
S50V - DDUNR/L - 15	VRI1399	VRI1574	50	47	420	35	63

**₺991**
**DNM..  
11 04..**
**₺1.091**
**DNM..  
15 04..**
**₺1.091**
**₺1.346**
**DNM..  
15 06..**
**₺2.113**
**₺2.552**

**TEKNİK ÇİZİM / TECHNICAL DRAWING**

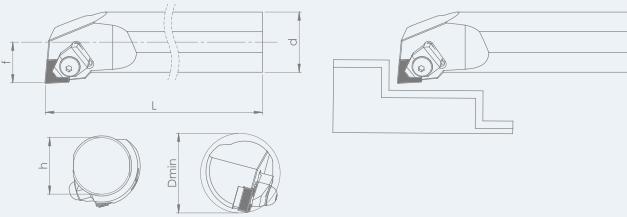
TAKIM KODU ORDERING CODE	ÜRÜN KODU PRODUCT CODE	KATER ÖLÇÜLERİ DIMENSIONS (mm)	KESİCİ UÇ INSERT	TL FİYAT TL PRICE					
<b>DDQNR/L 107,5°</b>	Sol Left	Sağ Right	d	h	L	f	Dmin		
S20R - DDQNR/L - 11	VR11401	VR11576	20	18	200	13	25	DNM.. 11 04..	₺991
S25S - DDQNR/L - 11	VR11403	VR11578	25	23	250	17	32		₺1.091
S25S - DDQNR/L - 15	VR11405	VR11580	25	23	250	17	32	DNM.. 15 06..	₺1.091
S32T - DDQNR/L - 15	VR11407	VR11582	32	30	300	22	40		₺1.346
S40U - DDQNR/L - 15	VR11409	VR11584	40	37	350	27	50		₺2.113
S50V - DDQNR/L - 15	VR11411	VR11586	50	47	420	35	63		₺2.552

**TEKNİK ÇİZİM / TECHNICAL DRAWING**

TAKIM KODU ORDERING CODE	ÜRÜN KODU PRODUCT CODE	KATER ÖLÇÜLERİ DIMENSIONS (mm)	KESİCİ UÇ INSERT	TL FİYAT TL PRICE					
<b>DCLNR/L 95°</b>	Sol Left	Sağ Right	d	h	L	f	Dmin		
S20R - DCLNR/L - 12	VR11413	VR11588	20	18	200	13	25	CNM.. 12 04..	₺991
S25S - DCLNR/L - 12	VR11415	VR11590	25	23	250	17	32		₺1.091
S32T - DCLNR/L - 12	VR11417	VR11592	32	30	300	22	40		₺1.346
S40U - DCLNR/L - 12	VR11419	VR11594	40	37	350	27	50		₺2.113
S50V - DCLNR/L - 12	VR11421	VR11596	50	47	420	35	63		₺2.552
S32T - DCLNR/L - 16	VR11423	VR11598	32	30	300	22	40	CNM.. 16 06..	₺1.531
S40U - DCLNR/L - 16	VR11425	VR11600	40	37	350	27	50		₺2.018
S50V - DCLNR/L - 16	VR11427	VR11602	50	47	420	35	63		₺2.552
S40U - DCLNR/L - 19	VR11429	VR11604	40	37	350	27	50	CNM.. 19 06..	₺2.018
S50V - DCLNR/L - 19	VR11431	VR11606	50	47	420	35	63		₺2.552

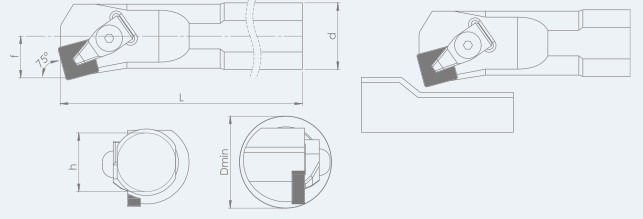
**TEKNİK ÇİZİM / TECHNICAL DRAWING**

TAKIM KODU ORDERING CODE	ÜRÜN KODU PRODUCT CODE	KATER ÖLÇÜLERİ DIMENSIONS (mm)	KESİCİ UÇ INSERT	TL FİYAT TL PRICE
-----------------------------	---------------------------	-----------------------------------	---------------------	----------------------

**DSKNR/L 75°**

Sol Left	Sağ Right	d	h	L	f	Dmin
-------------	--------------	---	---	---	---	------

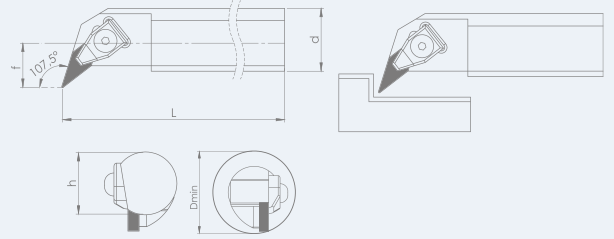

S25S - DSKNR/L - 12	VRI1433	VRI1608	25	23	250	17	32
S32T - DSKNR/L - 12	VRI1435	VRI1610	32	30	300	22	40
S40U - DSKNR/L - 12	VRI1437	VRI1612	40	37	350	27	50

**SNM..  
12 04..**
**₺1.091**
**₺1.346**
**₺2.113**

**TEKNİK ÇİZİM / TECHNICAL DRAWING**

TAKIM KODU ORDERING CODE	ÜRÜN KODU PRODUCT CODE	KATER ÖLÇÜLERİ DIMENSIONS (mm)	KESİCİ UÇ INSERT	TL FİYAT TL PRICE
-----------------------------	---------------------------	-----------------------------------	---------------------	----------------------

**DVQNR/L 107,5°**

Sol Left	Sağ Right	d	h	L	f	Dmin
-------------	--------------	---	---	---	---	------



S25S - DVQNR/L - 16	VRI1439	VRI1614	25	23	250	20	32
S32T - DVQNR/L - 16	VRI1441	VRI1616	32	30	300	22	40
S40U - DVQNR/L - 16	VRI1443	VRI1618	40	37,5	350	27	50

**VNM..  
16 04..**
**₺1.091**
**₺1.346**
**₺2.113**

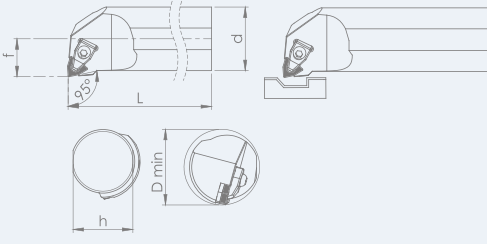

## TEKNİK ÇİZİM / TECHNICAL DRAWING

TAKIM KODU ORDERING CODE	ÜRÜN KODU PRODUCT CODE	KATER ÖLÇÜLERİ DIMENSIONS (mm)	KESİCİ UÇ INSERT	TL FİYAT TL PRICE					
<b>DWLNRL/L 95°</b>	<b>Sol Left</b>	<b>Sağ Right</b>	<b>d</b>	<b>h</b>	<b>L</b>	<b>f</b>	<b>Dmin</b>		
S20R - DWLNRL/L - 06	VRI1447	VRI1622	20	18	200	13	25		₺991
S25S - DWLNRL/L - 06	VRI1449	VRI1624	25	23	250	17	32	<b>WNM.. 06 04..</b>	₺1.091
S32T - DWLNRL/L - 06	VRI1451	VRI1626	32	30	300	22	40		₺1.346
S25S - DWLNRL/L - 08	VRI1453	VRI1628	25	23	250	17	32		₺1.091
S32T - DWLNRL/L - 08	VRI1455	VRI1630	32	30	300	22	40	<b>WNM.. 08 04..</b>	₺1.346
S40U - DWLNRL/L - 08	VRI1457	VRI1632	40	37	350	27	50		₺2.113
S50V - DWLNRL/L - 08	VRI1459	VRI1634	50	47	420	35	63		₺2.552

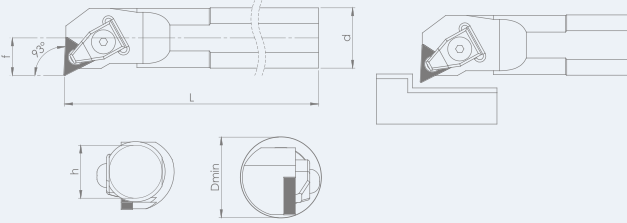

## TEKNİK ÇİZİM / TECHNICAL DRAWING

TAKIM KODU ORDERING CODE	ÜRÜN KODU PRODUCT CODE	KATER ÖLÇÜLERİ DIMENSIONS (mm)	KESİCİ UÇ INSERT	TL FİYAT TL PRICE					
<b>DTUNRL/L 93°</b>	<b>Sol Left</b>	<b>Sağ Right</b>	<b>d</b>	<b>h</b>	<b>L</b>	<b>f</b>	<b>Dmin</b>		
S25S - DTUNRL/L - 16	VRI1461	VRI1636	25	23	250	17	32		₺1.091
S32T - DTUNRL/L - 16	VRI1463	VRI1638	32	30	300	22	40	<b>TNM.. 16 04..</b>	₺1.346
S40U - DTUNRL/L - 16	VRI1465	VRI1640	40	37	350	27	50		₺2.113
S25S - DTUNRL/L - 22	VRI1467	VRI1642	25	23	250	17	32		₺1.091
S32T - DTUNRL/L - 22	VRI1469	VRI1644	32	30	300	22	40	<b>TNM.. 22 04..</b>	₺1.346
S40U - DTUNRL/L - 22	VRI1471	VRI1646	40	37	350	27	50		₺2.113
S50V - DTUNRL/L - 22	VRI1473	VRI1648	50	47	420	35	63		₺2.552

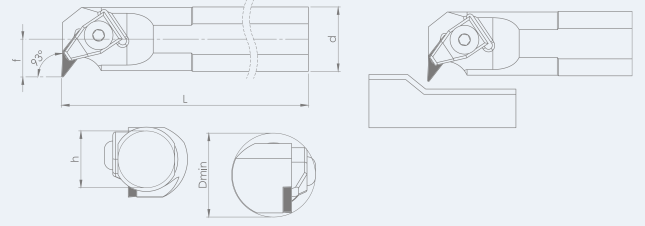

TEKNİK ÇİZİM / TECHNICAL DRAWING

TAKIM KODU ORDERING CODE	ÜRÜN KODU PRODUCT CODE	KATER ÖLÇÜLERİ DIMENSIONS (mm)	KESİCİ UÇ INSERT	TL FİYAT TL PRICE
-----------------------------	---------------------------	-----------------------------------	---------------------	----------------------

**DVUNR/L 93°**

Sol Left	Sağ Right	d	h	L	f	Dmin
-------------	--------------	---	---	---	---	------



S25S - DVUNR/L - 16	VRI1475	VRI1650	25	23	250	20	32
S32T - DVUNR/L - 16	VRI1477	VRI1652	32	30	300	22	40
S40U - DVUNR/L - 16	VRI1479	VRI1654	40	37,5	350	27	50

**VNM..  
16 04..**

₺1.091

₺1.346

₺2.113



[www.vorgen.com](http://www.vorgen.com)

**VORGEN®**

# M SİSTEM DELİK TORNA KATERLERİ

M SYSTEM BORING BARS



VORGEN® S25S MWLNR 08

VORGEN® S25S MT-NR 16

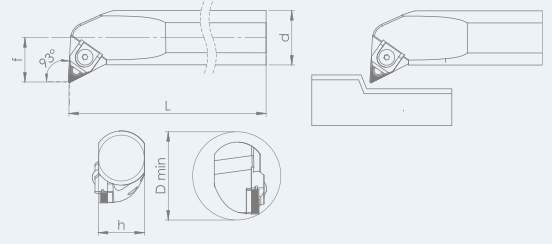
**TEKNİK ÇİZİM / TECHNICAL DRAWING**

TAKIM KODU ORDERING CODE	ÜRÜN KODU PRODUCT CODE	KATER ÖLÇÜLERİ DIMENSIONS (mm)	KESİCİ UÇ INSERT	TL FİYAT TL PRICE
-----------------------------	---------------------------	-----------------------------------	---------------------	----------------------

**MTUNR/L 93°**

Sol Left	Sağ Right	d	h	L	f	Dmin
-------------	--------------	---	---	---	---	------

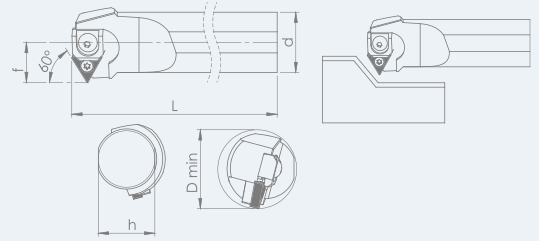

S20R - MTUNR/L - 16	VRI1481	VRI1656	20	18	200	13	25
S25S - MTUNR/L - 16	VRI1483	VRI1658	25	23	250	17	32
S32T - MTUNR/L - 16	VRI1485	VRI1660	32	30	300	22	40
S40U - MTUNR/L - 16	VRI1487	VRI1662	40	37	350	27	50
S50V - MTUNR/L - 16	VRI1971	VRI1972	50	47	420	35	63
S25S - MTUNR/L - 22	VRI1489	VRI1664	25	23	250	17	32
S32T - MTUNR/L - 22	VRI1491	VRI1666	32	30	300	22	40
S40U - MTUNR/L - 22	VRI1493	VRI1668	40	37	350	27	50
S50V - MTUNR/L - 22	VRI1495	VRI1670	50	47	420	35	63

**TNM..  
16 04..**
**₺991**
**₺1.091**
**₺1.346**
**₺2.113**
**₺2.552**
**TNM..  
22 04..**
**₺1.091**
**₺1.346**
**₺2.113**
**₺2.552**

**TEKNİK ÇİZİM / TECHNICAL DRAWING**

TAKIM KODU ORDERING CODE	ÜRÜN KODU PRODUCT CODE	KATER ÖLÇÜLERİ DIMENSIONS (mm)	KESİCİ UÇ INSERT	TL FİYAT TL PRICE
-----------------------------	---------------------------	-----------------------------------	---------------------	----------------------

**MT-NR/L 60°**

Sol Left	Sağ Right	d	h	L	f	Dmin
-------------	--------------	---	---	---	---	------



S25S - MT-NR/L - 16	VRI1497	VRI1672	25	23	250	17	32
S32T - MT-NR/L - 16	VRI1499	VRI1674	32	30	300	22	40
S40U - MT-NR/L - 16	VRI1975	VRI1976	40	37	350	27	50
S32T - MT-NR/L - 22	VRI1501	VRI1676	32	30	300	22	40
S40U - MT-NR/L - 22	VRI1503	VRI1678	40	37	350	27	50
S50V - MT-NR/L - 22	VRI1505	VRI1680	50	47	420	35	63

**TNM..  
16 04..**
**₺1.091**
**₺1.346**
**₺2.113**
**₺1.346**
**TNM..  
22 04..**
**₺1.346**
**₺2.113**
**₺2.552**



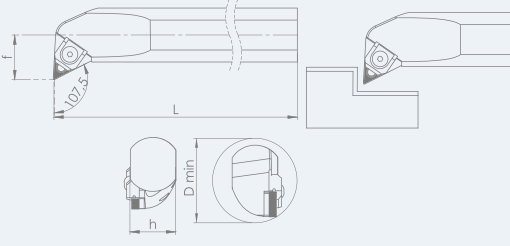

TEKNİK ÇİZİM / TECHNICAL DRAWING



TAKIM KODU ORDERING CODE	ÜRÜN KODU PRODUCT CODE	KATER ÖLÇÜLERİ DIMENSIONS (mm)	KESİCİ UÇ INSERT	TL FİYAT TL PRICE					
<b>MTQNR/L 107,5°</b>	<b>Sol Left</b>	<b>Sağ Right</b>	<b>d</b>	<b>h</b>	<b>L</b>	<b>f</b>	<b>Dmin</b>		
S20R - MTQNR/L - 16	VRI1507	VRI1682	20	18	200	13	25	TNM.. 16 04..	₺991
S25S - MTQNR/L - 16	VRI1509	VRI1684	25	23	250	17	32		₺1.091
S32T - MTQNR/L - 16	VRI1511	VRI1686	32	30	300	22	40		₺1.346
S40U - MTQNR/L - 16	VRI1513	VRI1688	40	37	350	27	50		₺2.113
S50V - MTQNR/L - 16	VRI1973	VRI1974	50	47	420	35	63		₺2.552
S25S - MTQNR/L - 22	VRI1517	VRI1692	25	23	250	17	32	TNM.. 22 04..	₺1.091
S32T - MTQNR/L - 22	VRI1519	VRI1694	32	30	300	22	40		₺1.346
S40U - MTQNR/L - 22	VRI1521	VRI1696	40	37	350	27	50		₺2.113
S50V - MTQNR/L - 22	VRI1523	VRI1698	50	47	420	35	63		₺2.552

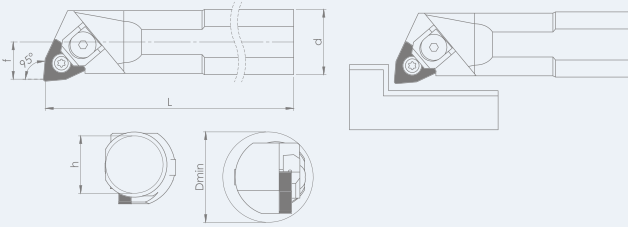

TEKNİK ÇİZİM / TECHNICAL DRAWING



TAKIM KODU ORDERING CODE	ÜRÜN KODU PRODUCT CODE	KATER ÖLÇÜLERİ DIMENSIONS (mm)	KESİCİ UÇ INSERT	TL FİYAT TL PRICE					
<b>MWLNR/L 95°</b>	<b>Sol Left</b>	<b>Sağ Right</b>	<b>d</b>	<b>h</b>	<b>L</b>	<b>f</b>	<b>Dmin</b>		
S20R - MWLNR/L - 06	VRI1525	VRI1700	20	18	200	13	25	WNM.. 06 03..	₺991
S25S - MWLNR/L - 06	VRI1527	VRI1702	25	23	250	17	32		₺1.091
S32T - MWLNR/L - 06	VRI1529	VRI1704	32	30	300	22	40		₺1.346
S20R - MWLNR/L - 08	VRI1531	VRI1706	20	18	200	13	25	WNM.. 08 04..	₺991
S25S - MWLNR/L - 08	VRI1533	VRI1708	25	23	250	17	32		₺1.091
S32T - MWLNR/L - 08	VRI1535	VRI1710	32	30	300	22	40		₺1.346
S40U - MWLNR/L - 08	VRI1537	VRI1712	40	37	350	27	50		₺2.113
S50V - MWLNR/L - 08	VRI1539	VRI1714	50	47	420	35	63		₺2.552

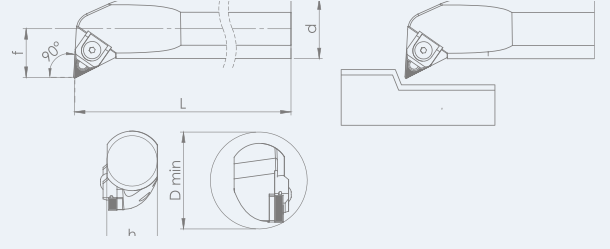

TEKNİK ÇİZİM / TECHNICAL DRAWING

TAKIM KODU ORDERING CODE	ÜRÜN KODU PRODUCT CODE	KATER ÖLÇÜLERİ DIMENSIONS (mm)	KESİCİ UÇ INSERT	TL FİYAT TL PRICE
-----------------------------	---------------------------	-----------------------------------	---------------------	----------------------

MTFNR/L 90°	Sol Left	Sağ Right	d	h	L	f	Dmin	 TNM.. 16 04..	TL PRICE
	S20R - MTFNR/L - 16	VRI1541	VRI1716	20	18	200	13		
S25S - MTFNR/L - 16	VRI1543	VRI1718	25	23	250	17	32	₺1.091	
S32T - MTFNR/L - 16	VRI1545	VRI1720	32	30	300	22	40	₺1.346	
S40U - MTFNR/L - 16	VRI1547	VRI1722	40	37	350	27	50	₺2.113	
S25S - MTFNR/L - 22	VRI1549	VRI1724	25	23	250	17	32	₺1.091	
S32T - MTFNR/L - 22	VRI1551	VRI1726	32	30	300	22	40	₺1.346	
S40U - MTFNR/L - 22	VRI1553	VRI1728	40	37	350	27	50	₺2.113	
S50V - MTFNR/L - 22	VRI1555	VRI1730	50	47	420	35	63	₺2.552	



[www.vorgen.com](http://www.vorgen.com)

**VORGEN®**

# C SİSTEM DELİK TORNA KATERLERİ

C SYSTEM BORING BARS

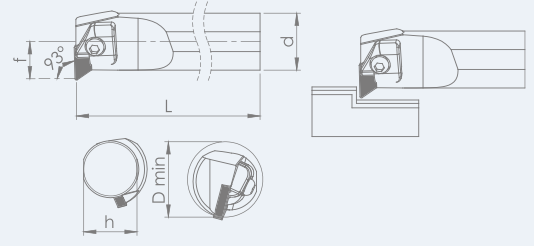

**TEKNİK ÇİZİM / TECHNICAL DRAWING**

TAKIM KODU ORDERING CODE	ÜRÜN KODU PRODUCT CODE	KATER ÖLÇÜLERİ DIMENSIONS (mm)	KESİCİ UÇ INSERT	TL FİYAT TL PRICE
-----------------------------	---------------------------	-----------------------------------	---------------------	----------------------

**CKUNR/L 93°**

Sol Left	Sağ Right	d	h	L	f	Dmin
-------------	--------------	---	---	---	---	------

S25S - CKUNR/L - 16	VRI1557	VRI1732	25	23	250	19	38
S28T - CKUNR/L - 16	VRI1559	VRI1734	28	26	290	19	38
S32T - CKUNR/L - 16	VRI1561	VRI1736	32	30	330	22	40
S40T - CKUNR/L - 16	VRI1563	VRI1738	40	37	400	27	50
S45V - CKUNR/L - 16	VRI1565	VRI1740	45	42	400	29	52
S50U - CKUNR/L - 16	VRI1567	VRI1742	50	47	420	35	63

**KNUX..  
16 R/L**

₺905

₺958

₺1.170

₺1.634

₺1.923

₺2.552

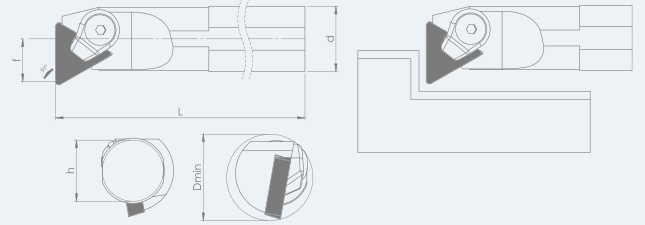
**TEKNİK ÇİZİM / TECHNICAL DRAWING**

TAKIM KODU ORDERING CODE	ÜRÜN KODU PRODUCT CODE	KATER ÖLÇÜLERİ DIMENSIONS (mm)	KESİCİ UÇ INSERT	TL FİYAT TL PRICE
-----------------------------	---------------------------	-----------------------------------	---------------------	----------------------

**CTFPR/L 91°**

Sol Left	Sağ Right	d	h	L	f	Dmin
-------------	--------------	---	---	---	---	------

S12Q - CTFPR/L - 11	VRI1569	VRI1744	12	11	125	9	16
S16R - CTFPR/L - 16	VRI1571	VRI1746	16	15	180	11	20
S20R - CTFPR/L - 16	VRI1573	VRI1748	20	18	200	13	25
S25S - CTFPR/L - 16	VRI1575	VRI1750	25	23	250	17	32
S25S - CTFPR/L - 22	VRI1577	VRI1752	25	23	250	17	32
S32T - CTFPR/L - 22	VRI1579	VRI1754	32	30	300	27	40

**TP..  
11 03..**

₺590

₺615

**TP..  
16 03..**

₺649

₺660

**TP..  
22 04..**

₺715

₺1.091

[www.vorgen.com](http://www.vorgen.com)

**VORGEN**<sup>®</sup>

# S SISTEM DELİK TORNA KATERLERİ

S SYSTEM BORING BARS

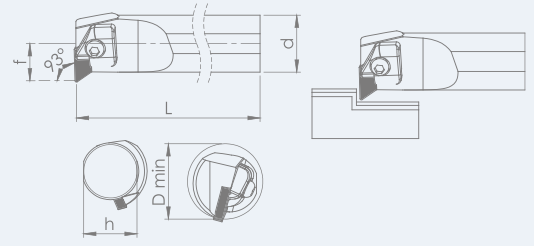

**TEKNİK ÇİZİM / TECHNICAL DRAWING**

TAKIM KODU ORDERING CODE	ÜRÜN KODU PRODUCT CODE	KATER ÖLÇÜLERİ DIMENSIONS (mm)	KESİCİ UÇ INSERT	TL FİYAT TL PRICE
-----------------------------	---------------------------	-----------------------------------	---------------------	----------------------

**SDUCR/L 93°**

Sol Left	Sağ Right	d	h	L	f	Dmin
-------------	--------------	---	---	---	---	------



S10J - SDUCR/L - 07	VRI1581	VRI1756	10	9	120	7	13
S12K - SDUCR/L - 07	VRI1583	VRI1758	12	11	125	9	16
S10-16M - SDUCR/L - 07	VRI1585	VRI1760	10-16	15	150	6	14
S12-16M - SDUCR/L - 07	VRI1587	VRI1762	12-16	15	150	8	16
S16Q - SDUCR/L - 07	VRI1589	VRI1764	16	14.5	180	11	20
S16Q - SDUCR/L - 11	VRI1591	VRI1766	16	14.5	180	11	20
S20R - SDUCR/L - 11	VRI1593	VRI1768	20	18.5	200	13	25
S25S - SDUCR/L - 11	VRI1595	VRI1770	25	23	250	17	32
S32T - SDUCR/L - 11	VRI1597	VRI1772	32	29.5	300	22	40

**DCM..  
07 02..**
**DCM..  
11 T3..**

₺445

₺463

₺556

₺556

₺556

₺556

₺580

₺675

₺1.200

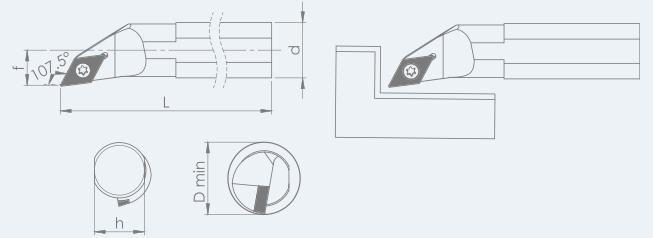
**TEKNİK ÇİZİM / TECHNICAL DRAWING**

TAKIM KODU ORDERING CODE	ÜRÜN KODU PRODUCT CODE	KATER ÖLÇÜLERİ DIMENSIONS (mm)	KESİCİ UÇ INSERT	TL FİYAT TL PRICE
-----------------------------	---------------------------	-----------------------------------	---------------------	----------------------

**SDQCR/L 107,5°**

Sol Left	Sağ Right	d	h	L	f	Dmin
-------------	--------------	---	---	---	---	------



S10J - SDQCR/L - 07	VRI1599	VRI1774	10	9	120	7	13
S12K - SDQCR/L - 07	VRI1601	VRI1776	12	11	125	9	16
S16Q - SDQCR/L - 07	VRI1603	VRI1778	16	14.5	180	11	20
S16Q - SDQCR/L - 11	VRI1607	VRI1782	16	14.5	180	11	20
S20R - SDQCR/L - 11	VRI1609	VRI1784	20	18.5	200	13	25
S25S - SDQCR/L - 11	VRI1611	VRI1786	25	23	250	17	32
S32T - SDQCR/L - 11	VRI1613	VRI1788	32	29.5	300	22	40

**DCM..  
07 02..**
**DCM..  
11 T3..**

₺445

₺463

₺556

₺556

₺580

₺675

₺1.200

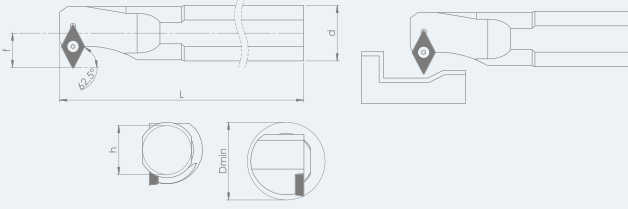
**TEKNİK ÇİZİM / TECHNICAL DRAWING**

TAKIM KODU ORDERING CODE	ÜRÜN KODU PRODUCT CODE	KATER ÖLÇÜLERİ DIMENSIONS (mm)	KESİCİ UÇ INSERT	TL FİYAT TL PRICE	
<b>SD-CR/L 62,5°</b>	<b>Sol</b> Left	<b>Sağ</b> Right	<b>d</b> <b>h</b> <b>L</b> <b>f</b> <b>Dmin</b>		
S10J - SD-CR/L - 07	VRI1615	VRI1790	10 9 120 7 13	₺445	
S12K - SD-CR/L - 07	VRI1617	VRI1792	12 11 125 9 16	DCM.. 07 02..	₺463
S16Q - SD-CR/L - 07	VRI1619	VRI1794	16 15 180 11 20	₺556	
S16Q - SD-CR/L - 11	VRI1621	VRI1796	16 15 180 11 20	DCM.. 11 T3..	₺556
S20R - SD-CR/L - 11	VRI1623	VRI1798	20 18 200 13 25	₺580	
S25S - SD-CR/L - 11	VRI1625	VRI1800	25 23 250 17 32	DCM.. 11 T3..	₺675
S32T - SD-CR/L - 11	VRI1627	VRI1802	32 30 300 22 40	DCM.. 11 T3..	₺1.200

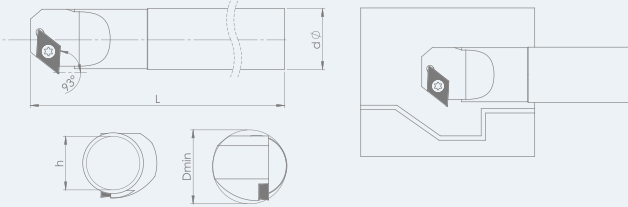
**TEKNİK ÇİZİM / TECHNICAL DRAWING**

TAKIM KODU ORDERING CODE	ÜRÜN KODU PRODUCT CODE	KATER ÖLÇÜLERİ DIMENSIONS (mm)	KESİCİ UÇ INSERT	TL FİYAT TL PRICE	
<b>SDZCR/L 93°</b>	<b>Sol</b> Left	<b>Sağ</b> Right	<b>d</b> <b>h</b> <b>L</b> <b>f</b> <b>Dmin</b>		
S12K - SDZCR/L - 07	VRI1629	VRI1804	12 11 125 9 16	DCM.. 07 02..	₺463
S16Q - SDZCR/L - 07	VRI1631	VRI1806	16 15 180 11 20	₺546	
S16Q - SDZCR/L - 11	VRI1633	VRI1808	16 15 180 11 20	₺546	
S20R - SDZCR/L - 11	VRI1635	VRI1810	20 18 200 13 25	DCM.. 11 T3..	₺580
S25S - SDZCR/L - 11	VRI1637	VRI1812	25 23 250 17 32	₺675	
S32T - SDZCR/L - 11	VRI1639	VRI1814	32 30 300 22 40	₺1.200	

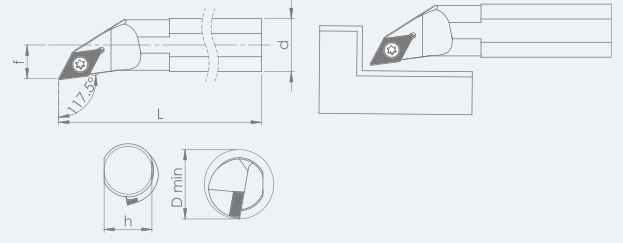
**TEKNİK ÇİZİM / TECHNICAL DRAWING**

TAKIM KODU ORDERING CODE	ÜRÜN KODU PRODUCT CODE	KATER ÖLÇÜLERİ DIMENSIONS (mm)	KESİCİ UÇ INSERT	TL FİYAT TL PRICE
-----------------------------	---------------------------	-----------------------------------	---------------------	----------------------

**SDXCR/L 117,5°**

Sol Left	Sağ Right	d	h	L	f	Dmin
-------------	--------------	---	---	---	---	------



S12K - SDXCR/L - 07 VRI1641 VRI1816 12 11 125 9 16

DCM..  
07 02.. ₺463

S16Q - SDXCR/L - 07 VRI1643 VRI1818 16 14 180 11 20

₺546

S16Q - SDXCR/L - 11 VRI1645 VRI1820 16 14 180 11 20

₺546

S20R - SDXCR/L - 11 VRI1647 VRI1822 20 18 200 13 25

₺580

S25S - SDXCR/L - 11 VRI1649 VRI1824 25 23 250 17 32

DCM..  
11 T3.. ₺675

S32T - SDXCR/L - 11 VRI1651 VRI1826 32 30 300 22 40

₺1.200

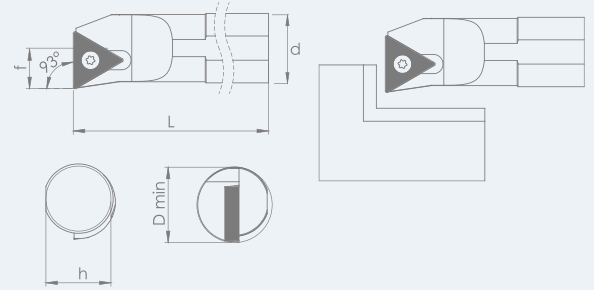
**TEKNİK ÇİZİM / TECHNICAL DRAWING**

TAKIM KODU ORDERING CODE	ÜRÜN KODU PRODUCT CODE	KATER ÖLÇÜLERİ DIMENSIONS (mm)	KESİCİ UÇ INSERT	TL FİYAT TL PRICE
-----------------------------	---------------------------	-----------------------------------	---------------------	----------------------

**STUPR 93°**

Sol Left	Sağ Right	d	h	L	f	Dmin
-------------	--------------	---	---	---	---	------



S10J - STUPR/L - 11 VRI1653 VRI1828 10 9.5 120 7 13

₺445

S12K - STUPR/L - 11 VRI1655 VRI1830 12 10.5 125 9 16

TPM..  
11 03.. ₺463

S16Q - STUPR/L - 11 VRI1657 VRI1832 16 14.5 180 11 20

₺546

S20R - STUPR/L - 11 VRI1659 VRI1834 20 18.5 200 13 25

₺580



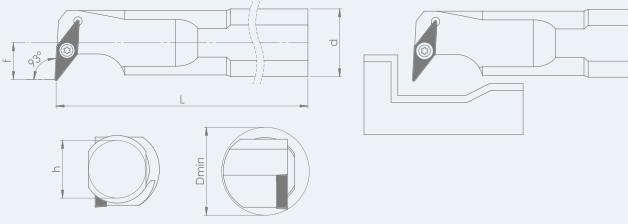

TEKNİK ÇİZİM / TECHNICAL DRAWING



TAKIM KODU ORDERING CODE	ÜRÜN KODU PRODUCT CODE	KATER ÖLÇÜLERİ DIMENSIONS (mm)	KESİCİ UÇ INSERT	TL FİYAT TL PRICE
<b>SVUBR/L 93°</b>	<b>Sol</b> Left	<b>Sağ</b> Right	<b>d</b> <b>h</b> <b>L</b> <b>f</b> <b>Dmin</b>	
S16Q - SVUBR/L - 11	VRI1661	VRI1836	16 15 180 11 20	<b>VBM..</b> <b>11 03..</b> ₺546
S20R - SVUBR/L - 11	VRI1663	VRI1838	20 18 200 13 25	₺580
S25S - SVUBR/L - 16	VRI1665	VRI1840	25 23 250 17 32	₺793
S32T - SVUBR/L - 16	VRI1667	VRI1842	32 30 300 22 40	<b>VBM..</b> <b>16 04..</b> ₺1.200
S40U - SVUBR/L - 16	VRI1669	VRI1844	40 37 350 27 50	₺1.994

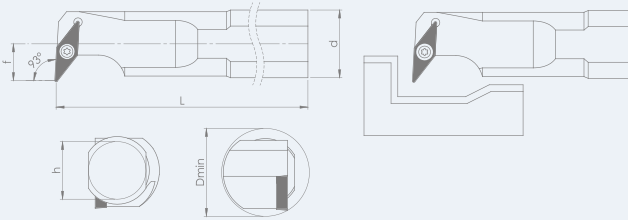

TEKNİK ÇİZİM / TECHNICAL DRAWING

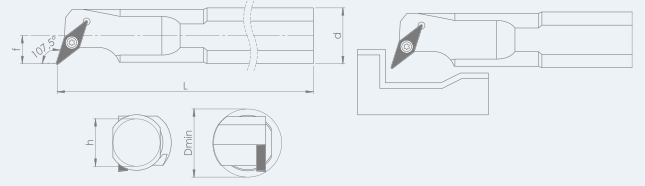

TAKIM KODU ORDERING CODE	ÜRÜN KODU PRODUCT CODE	KATER ÖLÇÜLERİ DIMENSIONS (mm)	KESİCİ UÇ INSERT	TL FİYAT TL PRICE
<b>SVUCR/L 93°</b>	<b>Sol</b> Left	<b>Sağ</b> Right	<b>d</b> <b>h</b> <b>L</b> <b>f</b> <b>Dmin</b>	
S16Q - SVUCR/L - 11	VRI1671	VRI1846	16 15 180 11 20	<b>VCM..</b> <b>11 03..</b> ₺546
S20R - SVUCR/L - 11	VRI1673	VRI1848	20 18 200 13 25	₺580
S25S - SVUCR/L - 16	VRI1675	VRI1850	25 23 250 17 32	₺793
S32T - SVUCR/L - 16	VRI1677	VRI1852	32 30 300 22 40	<b>VCM..</b> <b>16 04..</b> ₺1.200
S40U - SVUCR/L - 16	VRI1679	VRI1854	40 37 350 27 50	₺1.994

**TEKNİK ÇİZİM / TECHNICAL DRAWING**

TAKIM KODU ORDERING CODE	ÜRÜN KODU PRODUCT CODE	KATER ÖLÇÜLERİ DIMENSIONS (mm)	KESİCİ UÇ INSERT	TL FİYAT TL PRICE
-----------------------------	---------------------------	-----------------------------------	---------------------	----------------------

**SVQBR/L 107,5°**

Sol Left	Sağ Right	d	h	L	f	Dmin
-------------	--------------	---	---	---	---	------

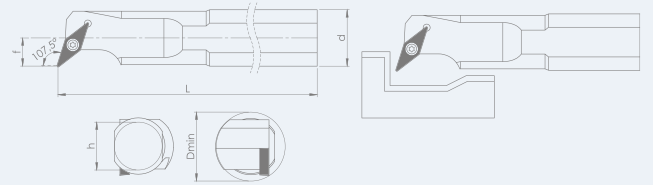

S16Q - SVQBR/L - 11	VRI1681	VRI1856	16	15	180	11	20
S20R - SVQBR/L - 11	VRI1683	VRI1858	20	18	200	13	25
S25S - SVQBR/L - 16	VRI1685	VRI1860	25	23	250	17	32
S32T - SVQBR/L - 16	VRI1687	VRI1862	32	30	300	22	40
S40U - SVQBR/L - 16	VRI1689	VRI1864	40	37	350	27	50

**VBM..  
11 03..**
**₺546**
**₺580**
**₺793**
**VBM..  
16 04..**
**₺1.200**
**₺1.994**

**TEKNİK ÇİZİM / TECHNICAL DRAWING**

TAKIM KODU ORDERING CODE	ÜRÜN KODU PRODUCT CODE	KATER ÖLÇÜLERİ DIMENSIONS (mm)	KESİCİ UÇ INSERT	TL FİYAT TL PRICE
-----------------------------	---------------------------	-----------------------------------	---------------------	----------------------

**SVQCR/L 107,5°**

Sol Left	Sağ Right	d	h	L	f	Dmin
-------------	--------------	---	---	---	---	------



S16Q - SVQCR/L - 11	VRI1691	VRI1866	16	15	180	11	20
S20R - SVQCR/L - 11	VRI1693	VRI1868	20	18	200	13	25
S25S - SVQCR/L - 16	VRI1695	VRI1870	25	23	250	17	32
S32T - SVQCR/L - 16	VRI1697	VRI1872	32	30	300	22	40
S40U - SVQCR/L - 16	VRI1699	VRI1874	40	37	350	27	50

**VCM..  
11 03..**
**₺546**
**₺580**
**₺793**
**VCM..  
16 04..**
**₺1.200**
**₺1.994**

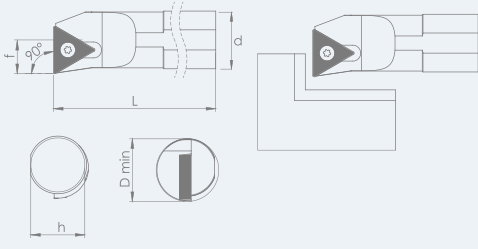

## TEKNİK ÇİZİM / TECHNICAL DRAWING

TAKIM KODU ORDERING CODE	ÜRÜN KODU PRODUCT CODE	KATER ÖLÇÜLERİ DIMENSIONS (mm)	KESİCİ UÇ INSERT	TL FİYAT TL PRICE	
<b>STFCR/L</b> 90°	<b>Sol</b> Left	<b>Sağ</b> Right	<b>d</b> <b>h</b> <b>L</b> <b>f</b> <b>Dmin</b>		
S08H - STFCR/L - 09	VRI1701	VRI1876	08 7 115 6 11	TCM.. 09 02	₺417
S10J - STFCR/L - 09	VRI1703	VRI1878	10 9 120 7 13		₺445
S12K - STFCR/L - 09	VRI1705	VRI1880	12 11 125 9 16		₺463
S10J - STFCR/L - 11	VRI1977	VRI1978	10 9 120 7 13		₺445
S12K - STFCR/L - 11	VRI1707	VRI1882	12 11 125 9 16	TCM.. 11 T3..	₺463
S16Q - STFCR/L - 11	VRI1709	VRI1884	16 15 180 11 20		₺546
S20R - STFCR/L - 11	VRI1711	VRI1886	20 18 200 13 25		₺580
S16Q - STFCR/L - 16	VRI1713	VRI1888	16 15 180 11 20		₺546
S20R - STFCR/L - 16	VRI1715	VRI1890	20 18 200 13 25	TCM.. 16T3..	₺580
S25S - STFCR/L - 16	VRI1717	VRI1892	25 23 250 17 32		₺672
S32T - STFCR/L - 16	VRI1719	VRI1894	32 30 300 22 40		₺1.200

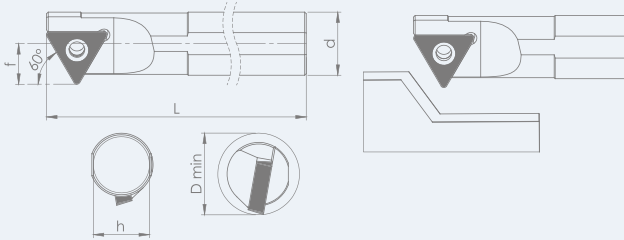

## TEKNİK ÇİZİM / TECHNICAL DRAWING

TAKIM KODU ORDERING CODE	ÜRÜN KODU PRODUCT CODE	KATER ÖLÇÜLERİ DIMENSIONS (mm)	KESİCİ UÇ INSERT	TL FİYAT TL PRICE	
<b>ST-CR/L</b> 60°	<b>Sol</b> Left	<b>Sağ</b> Right	<b>d</b> <b>h</b> <b>L</b> <b>f</b> <b>Dmin</b>		
S16Q - ST-CR/L - 11	VRI1721	VRI1896	16 15 180 11 20	TCM.. 11 T3..	₺546
S20R - ST-CR/L - 11	VRI1723	VRI1898	20 18 200 13 25		₺580
S16Q - ST-CR/L - 16	VRI1725	VRI1900	16 15 180 11 20		₺546
S20R - ST-CR/L - 16	VRI1727	VRI1902	20 18 200 13 25	TCM.. 16 T3..	₺580
S25S - ST-CR/L - 16	VRI1729	VRI1904	25 23 250 17 32		₺672
S32T - ST-CR/L - 16	VRI1731	VRI1906	32 30 300 22 40		₺1.200

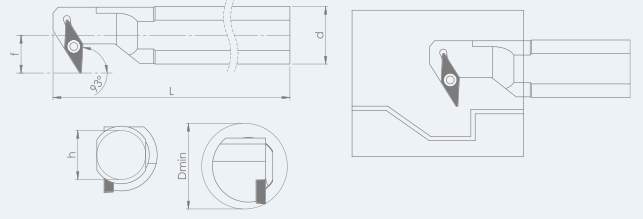

**TEKNİK ÇİZİM / TECHNICAL DRAWING**

TAKIM KODU ORDERING CODE	ÜRÜN KODU PRODUCT CODE	KATER ÖLÇÜLERİ DIMENSIONS (mm)	KESİCİ UÇ INSERT	TL FİYAT TL PRICE
-----------------------------	---------------------------	-----------------------------------	---------------------	----------------------

**SVZBR/L 93°**

Sol Left	Sağ Right	d	h	L	f	Dmin
-------------	--------------	---	---	---	---	------

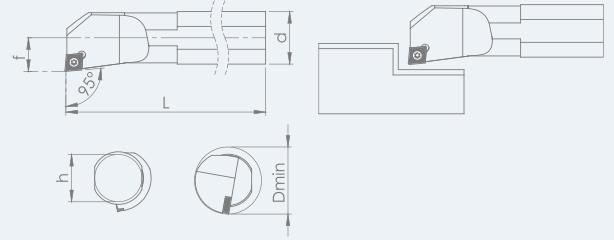
S25S - SVZBR/L - 16	VRI1733	VRI1908	25	23	250	17	32
S32T - SVZBR/L - 16	VRI1735	VRI1910	32	30	300	22	40
S40U - SVZBR/L - 16	VRI1737	VRI1912	40	37	350	27	50

**VBM..  
16 04..**
**₺793**
**₺1.200**
**₺1.994**

**TEKNİK ÇİZİM / TECHNICAL DRAWING**

TAKIM KODU ORDERING CODE	ÜRÜN KODU PRODUCT CODE	KATER ÖLÇÜLERİ DIMENSIONS (mm)	KESİCİ UÇ INSERT	TL FİYAT TL PRICE
-----------------------------	---------------------------	-----------------------------------	---------------------	----------------------

**SCLCR/L 95°**

Sol Left	Sağ Right	d	h	L	f	Dmin
-------------	--------------	---	---	---	---	------

S06-08H - SCLCR/L - 06	VRI1739	VRI1916	06-08	7	115	4,5	8
S08H - SCLCR/L - 06	VRI1741	VRI1918	08	7	115	6	11
S10J - SCLCR/L - 06	VRI1743	VRI1920	10	9	120	7	13
S12K - SCLCR/L - 06	VRI1745	VRI1922	12	11	125	9	16
S08-16M - SCLCR/L - 06	VRI1747	VRI1924	08-16	15	150	6	11
S10-16M - SCLCR/L - 06	VRI1749	VRI1926	10-16	15	150	7	13
S12-16M - SCLCR/L - 06	VRI1751	VRI1928	12-16	15	150	9	16
S12K - SCLCR/L - 09	VRI1753	VRI1930	12	11	125	9	16
S16Q - SCLCR/L - 09	VRI1755	VRI1932	16	15	180	11	21
S20R - SCLCR/L - 09	VRI1757	VRI1934	20	18	200	13	25
S25S - SCLCR/L - 09	VRI1759	VRI1936	25	23	250	17	32
S25S - SCLCR/L - 12	VRI1761	VRI1938	25	23	250	17	32
S32T - SCLCR/L - 12	VRI1763	VRI1940	32	30	300	22	40

**CCM..  
06 02..**
**₺417**
**₺417**
**₺445**
**₺463**
**₺533**
**₺533**
**₺533**
**₺463**
**CCM..  
09 T3..**
**₺533**
**₺562**
**₺649**
**CCM..  
12 04..**
**₺649**
**₺1.200**

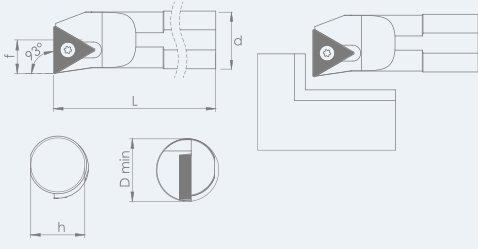

## TEKNİK ÇİZİM / TECHNICAL DRAWING

TAKIM KODU ORDERING CODE	ÜRÜN KODU PRODUCT CODE	KATER ÖLÇÜLERİ DIMENSIONS (mm)	KESİCİ UÇ INSERT	TL FİYAT TL PRICE					
<b>STUCR/L 93°</b>	<b>Sol</b> Left	<b>Sağ</b> Right	<b>d</b>	<b>h</b>	<b>L</b>	<b>f</b>	<b>Dmin</b>		
S10J - STUCR/L - 09	VRI1765	VRI1942	10	9	120	7	13	TCM.. 09 02	₺428
S12K - STUCR/L - 09	VRI1767	VRI1944	12	11	125	9	16		₺445
S10J - STUCR/L - 11	VRI1979	VRI1980	10	9	120	7	13		₺428
S12K - STUCR/L - 11	VRI1769	VRI1946	12	11	125	9	16	TCM.. 11 T3..	₺445
S16Q - STUCR/L - 11	VRI1771	VRI1948	16	15	180	11	20		₺533
S20R - STUCR/L - 11	VRI1773	VRI1950	20	18	200	13	25		₺562
S16Q - STUCR/L - 16	VRI1775	VRI1952	16	15	180	11	20		₺533
S20R - STUCR/L - 16	VRI1777	VRI1954	20	18	200	13	25	TCM.. 16 T3..	₺562
S25S - STUCR/L - 16	VRI1779	VRI1956	25	23	250	17	32		₺649
S32T - STUCR/L - 16	VRI1781	VRI1958	32	30	300	22	40		₺1.200

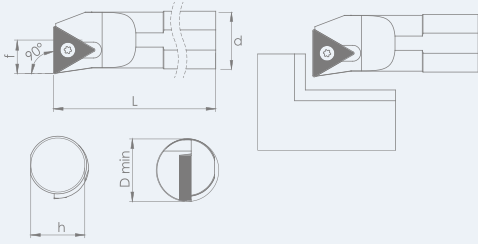

## TEKNİK ÇİZİM / TECHNICAL DRAWING

TAKIM KODU ORDERING CODE	ÜRÜN KODU PRODUCT CODE	KATER ÖLÇÜLERİ DIMENSIONS (mm)	KESİCİ UÇ INSERT	TL FİYAT TL PRICE					
<b>STFCR/L 90°</b>	<b>Sol</b> Left	<b>Sağ</b> Right	<b>d</b>	<b>h</b>	<b>L</b>	<b>f</b>	<b>Dmin</b>		
S10J - STFCR/L - 11	VRI1783	VRI1960	10	09	120	7	13	TPM.. 11 03..	₺428
S12K - STFCR/L - 11	VRI1785	VRI1962	12	11	125	9	16		₺445
S16Q - STFCR/L - 11	VRI1787	VRI1964	16	15	180	11	20		₺533
S20R - STFCR/L - 11	VRI1789	VRI1966	20	18	200	13	25		₺562

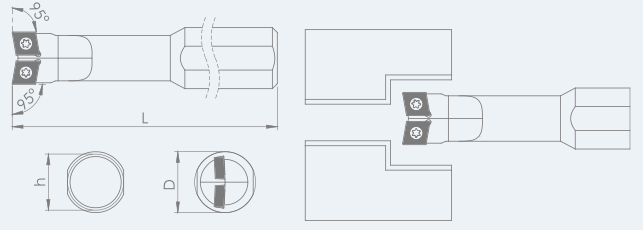

TEKNİK ÇİZİM / TECHNICAL DRAWING

TAKIM KODU  
ORDERING CODE

ÜRÜN KODU  
PRODUCT CODE

KATER ÖLÇÜLERİ  
DIMENSIONS (mm)

KESİCİ UÇ  
INSERT

TL FİYAT  
TL PRICE

**SCR-SCL 95°**

d	h	L	f	Dmin
---	---	---	---	------



S25S - SCR-SCL - 09

VR11968

25 23 250 22 X

CCM..  
09 T3..

₺1.412

S32T - SCR-SCL - 09

VR11970

32 30 300 27 X

₺1.628





[www.vorgen.com](http://www.vorgen.com)

**VORGEN®**

## **VIDA TAKIMLARI**

SCREW PLUGS



**VORGEN®**  
SER 2525 M16

PREMIUM QUALITY  
MATERIALS  
MADE IN ITALY

ALPES

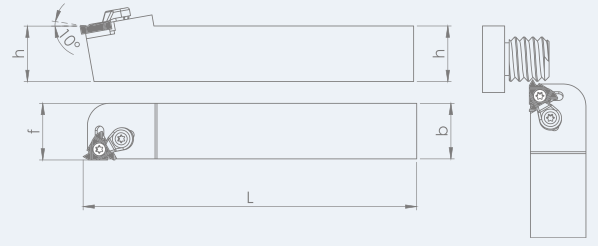

TEKNİK ÇİZİM / TECHNICAL DRAWING

TAKIM KODU ORDERING CODE	ÜRÜN KODU PRODUCT CODE	KATER ÖLÇÜLERİ DIMENSIONS (mm)	KESİCİ UÇ INSERT	TL FİYAT TL PRICE
-----------------------------	---------------------------	-----------------------------------	---------------------	----------------------

SER/L	90°	Sol Left	Sağ Right	h	b	L	f	ER/L.11	TL FİYAT TL PRICE
		SER/L - 0808 - F11	VRE1791	VRE1972	08	08	80		
SER/L - 1010 - F11	VRE1793	VRE1974	10	10	80	11	€672		
SER/L - 1212 - F11	VRE1795	VRE1976	12	12	80	11	€672		
SER/L - 1616 - H11	VRE1797	VRE1978	16	16	100	16	€710		
SER/L - 1212 - H16	VRE1799	VRE1980	12	12	100	14,5	€672		
SER/L - 1616 - H16	VRE1801	VRE1982	16	16	100	16	€710		
SER/L - 2020 - K16	VRE1803	VRE1984	20	20	125	20	€748		
SER/L - 2525 - M16	VRE1805	VRE1986	25	25	150	25	€777		
SER/L - 3232 - P16	VRE1807	VRE1988	32	32	170	32	€982		
SER/L - 2525 - M22	VRE1809	VRE1990	25	25	150	25	€867		
SER/L - 3232 - P22	VRE1811	VRE1992	32	32	170	32	€982		



TEKNİK ÇİZİM / TECHNICAL DRAWING

TAKIM KODU ORDERING CODE	ÜRÜN KODU PRODUCT CODE	KATER ÖLÇÜLERİ DIMENSIONS (mm)	KESİCİ UÇ INSERT	TL FİYAT TL PRICE
-----------------------------	---------------------------	-----------------------------------	---------------------	----------------------

TER/L	90°	Sol Left	Sağ Right	h	b	L	f	ER/L.16	TL FİYAT TL PRICE
		TER/L - 2020 - K16	VRE2027	VRE2028	20	20	125		
TER/L - 2525 - M16	VRE2029	VRE2030	25	25	150	25	€811		





## TEKNİK ÇİZİM / TECHNICAL DRAWING

TAKIM KODU ORDERING CODE	ÜRÜN KODU PRODUCT CODE	KATER ÖLÇÜLERİ DIMENSIONS (mm)						KESİCİ UÇ INSERT	TL FİYAT TL PRICE
STIR/L	90°	Sol Left	Sağ Right	d	h	L	f	Dmin	
		STIR/L - S10J - 11	VRE1817	VRE1998	10	9	120	7,4	
STIR/L - S12K - 11	VRE1819	VRE2000	12	11	125	8,4	12	IR/L.11	₺550
STIR/L - S16Q - 11	VRE1821	VRE2002	16	15	180	7,4	16		₺641
STIR/L - S13-16M - 16	VRE1823	VRE2004	16	14,5	150	9,5	15		₺641
STIR/L - S16Q - 16	VRE1825	VRE2006	16	15	180	7,4	12		₺641
STIR/L - S20R - 16	VRE1827	VRE2008	20	18	200	13,7	22		₺651
STIR/L - S25S - 16	VRE1829	VRE2010	25	23	250	16,2	28	IR/L.16	₺820
STIR/L - S32T - 16	VRE1831	VRE2012	32	30	300	19,7	36		₺1.301
STIR/L - S40T - 16	VRE1833	VRE2014	40	37	300	23,7	44		₺2.062
STIR/L - S50U - 16	VRE2025	VRE2026	50	47	350	30,6	58		₺2.552
STIR/L - S20R - 22	VRE1835	VRE2016	20	18	200	14	26		₺692
STIR/L - S25S - 22	VRE1837	VRE2018	25	23	250	18,1	28		₺837
STIR/L - S32T - 22	VRE1839	VRE2020	32	30	300	21,6	38	IR/L.22	₺1.352
STIR/L - S40T - 22	VRE1841	VRE2022	40	37	300	25,6	16		₺2.062
STIR/L - S50U - 22	VRE1843	VRE2024	50	47	350	30,6	58		₺2.552

[www.vorgen.com](http://www.vorgen.com)



---

# DIŐ ÇAP KANAL AÇMA TAKIMLARI

EXTERNAL GROOVING TOOLHOLDERS





HORN UCUNA UYGUNDUR

TEKNİK ÇİZİM / TECHNICAL DRAWING

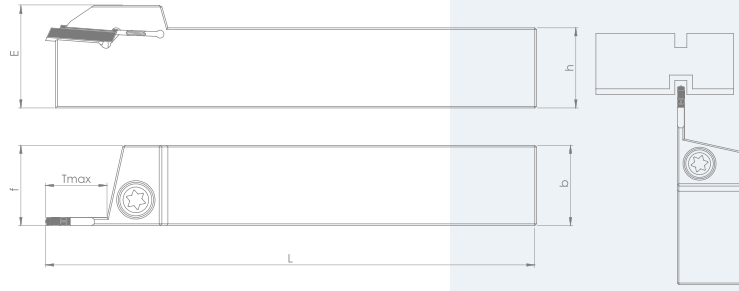
 TAKIM KODU  
ORDERING CODE

 ÜRÜN KODU  
PRODUCT CODE

 KATER ÖLÇÜLERİ  
DIMENSIONS (mm)

 KESİCİ UÇ  
INSERT

 TL FİYAT  
TL PRICE

BKTR/L KH	Sol Left	Sağ Right	h	b	L	f	E	A	Tmax		
BKTR/L-KH-1212-2C	VRB1845	VRB2026	12	12	100	12,3	24	1,8	15	S224.2	₺985
BKTR/L-KH-1616-2C	VRB1847	VRB2028	16	16	125	16	29	1,8	15		₺1.015
BKTR/L-KH-2020-2C	VRB1849	VRB2030	20	20	125	20	29	1,8	15		₺1.066
BKTR/L-KH-2525-2C	VRB1851	VRB2032	25	25	150	25	34	1,8	15	S224.3	₺1.102
BKTR/L-KH-2020-3C	VRB1853	VRB2034	20	20	125	20	29	2,5	20		₺1.066
BKTR/L-KH-2525-3C	VRB1855	VRB2036	25	25	150	25	34	3	20	S224.4	₺1.102
BKTR/L-KH-2020-4C	VRB1857	VRB2038	20	20	125	20	29	3	22	S224.4	₺1.066
BKTR/L-KH-2525-4C	VRB1859	VRB2040	25	25	150	25	34	4	22		₺1.102
BKTR/L-KH-2020-5C	VRB1861	VRB2042	20	20	125	20	29	4,2	22	S224.5	₺1.066
BKTR/L-KH-2525-5C	VRB1863	VRB2044	25	25	150	25	34	2,5	25		₺1.102



HORN UCUNA UYGUNDUR

TEKNİK ÇİZİM / TECHNICAL DRAWING

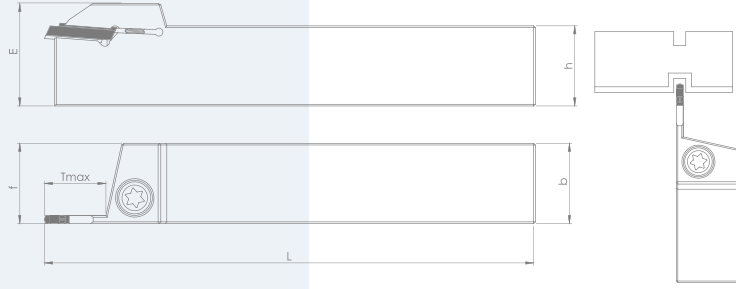
TAKIM KODU  
ORDERING CODEÜRÜN KODU  
PRODUCT CODEKATER ÖLÇÜLERİ  
DIMENSIONS (mm)KESİCİ UÇ  
INSERTTL FİYAT  
TL PRICE**BKTR/L BH**

	Sol Left	Sağ Right	h	b	L	f	E	A	Tmax		
BKTR/L-BH-2020-3C	VRB1865	VRB2046	20	20	125	20	30	2,5	20		₺1.066
BKTR/L-BH-2525-3C	VRB1867	VRB2048	32	32	150	32	34	2,5	20	<b>S229.3</b>	₺1.102
BKTR/L-BH-3232-3C	VRB1869	VRB2050	32	32	170	32	42	2,5	20		₺1.273
BKTR/L-BH-2020-4C	VRB1871	VRB2052	20	20	125	20	30	2,5	22		₺1.066
BKTR/L-BH-2525-4C	VRB1873	VRB2054	25	25	150	25	34	3,5	22	<b>S229.4</b>	₺1.102
BKTR/L-BH-3232-4C	VRB1875	VRB2056	32	32	170	32	42	3,5	22		₺1.273
BKTR/L-BH-2525-5C	VRB1877	VRB2058	25	25	150	25	34	4,5	25		₺1.102
BKTR/L-BH-3232-5C	VRB1879	VRB2060	32	32	170	32	42	4,5	25	<b>S229.5</b>	₺1.273



ISCAR UCUNA UYGUNDUR

TEKNİK ÇİZİM / TECHNICAL DRAWING



TAKIM KODU ORDERING CODE	ÜRÜN KODU PRODUCT CODE	KATER ÖLÇÜLERİ DIMENSIONS (mm)	KESİCİ UÇ INSERT	TL FİYAT TL PRICE							
<b>BKTR/L IS</b>	<b>Sol Left</b>	<b>Sağ Right</b>	<b>h</b>	<b>b</b>	<b>L</b>	<b>f</b>	<b>E</b>	<b>A</b>	<b>Tmax</b>		
BKTR/L-IS-1212-2C	VRB1881	VRB2062	12	12	100	12	24	1,8	15		₺985
BKTR/L-IS-1616-2C	VRB1883	VRB2064	16	16	125	16	30	1,8	15		₺1.015
BKTR/L-IS-2020-2C	VRB1885	VRB2066	20	20	125	20	30	1,8	17	<b>DGN.2</b>	₺1.066
BKTR/L-IS-2525-2C	VRB1887	VRB2068	25	25	150	25	34	1,8	17		₺1.102
BKTR/L-IS-3232-2C	VRB1889	VRB2070	32	32	170	32	42	1,8	15		₺1.273
BKTR/L-IS-1212-3C	VRB1891	VRB2072	12	12	100	12	24	2,5	17		₺985
BKTR/L-IS-1616-3C	VRB1893	VRB2074	16	16	125	16	30	2,5	15		₺1.015
BKTR/L-IS-2020-3C	VRB1895	VRB2076	20	20	125	20	30	2,5	20	<b>DGN.3</b>	₺1.066
BKTR/L-IS-2525-3C	VRB1897	VRB2078	25	25	150	25	34	2,5	22		₺1.102
BKTR/L-IS-3232-3C	VRB1899	VRB2080	32	32	170	32	42	2,5	22		₺1.273
BKTR/L-IS-2020-4C	VRB1901	VRB2082	20	20	125	20	30	3	20		₺1.066
BKTR/L-IS-2525-4C	VRB1903	VRB2084	25	25	150	25	34	3	22	<b>DGN.4</b>	₺1.102
BKTR/L-IS-3232-4C	VRB1905	VRB2086	32	32	170	32	42	3	22		₺1.273
BKTR/L-IS-2525-5C	VRB1907	VRB2088	25	25	150	25	34	4,2	25	<b>DGN.5</b>	₺1.102
BKTR/L-IS-2525-3C (T.MAX-30)	VRB2457	VRB2458	25	25	150	25	34	2,5	30	<b>DGN.3</b>	₺1.284
BKTR/L-IS-2525-4C (T.MAX-30)	VRB2459	VRB2460	25	25	150	25	34	3	30	<b>DGN.4</b>	₺1.284



KORLOY UCUNA UYGUNDUR

TEKNİK ÇİZİM / TECHNICAL DRAWING



TAKIM KODU ORDERING CODE	ÜRÜN KODU PRODUCT CODE	KATER ÖLÇÜLERİ DIMENSIONS (mm)								KESİCİ UÇ INSERT	TL FİYAT TL PRICE
BKTR/L JK	Sol Left	Sağ Right	h	b	L	f	E	A	Tmax	MGM.1.5	
	BKTR/L-JK-1212-1.5C	VRB2461	VRB2462	12	12	100	12	24	1,4		
BKTR/L-JK-1616-1.5C	VRB2463	VRB2464	16	16	125	16	30	1,4	15		₺1.015
BKTR/L-JK-2020-1.5 C	VRB2465	VRB2466	20	20	125	20	30	1,4	15		₺1.066
BKTR/L-JK-2525-1.5C	VRB2467	VRB2468	25	25	150	25	34	1,4	15		₺1.102
BKTR/L-JK-1212-2C	VRB1909	VRB2090	12	12	100	12	24	1,8	15	MGM.2	₺985
BKTR/L-JK-1616-2C	VRB1911	VRB2092	16	16	125	16	30	1,8	15		₺1.015
BKTR/L-JK-2020-2C	VRB1913	VRB2094	20	20	125	20	30	1,8	15		₺1.066
BKTR/L-JK-2525-2C	VRB1915	VRB2096	25	25	150	25	34	1,8	15		₺1.102
BKTR/L-JK-3232-2C	VRB1917	VRB2098	32	32	170	32	42	1,8	15		₺1.273
BKTR/L-JK-1212-3C	VRB1919	VRB2100	12	12	100	12	24	18	15	MGM.3	₺985
BKTR/L-JK-1616-3C	VRB1921	VRB2102	16	16	125	16	30	2,5	15		₺1.015
BKTR/L-JK-2020-3C	VRB1923	VRB2104	20	20	125	20	30	2,5	20		₺1.066
BKTR/L-JK-2525-3C	VRB1925	VRB2106	25	25	150	25	34	2,5	22		₺1.102
BKTR/L-JK-3232-3C	VRB1927	VRB2108	32	32	170	32	42	2,5	22		₺1.273
BKTR/L-JK-2020-4C	VRB1929	VRB2110	20	20	125	20	30	3	22	MGM.4	₺1.066
BKTR/L-JK-2525-4C	VRB1931	VRB2112	25	25	150	25	34	3	22		₺1.102
BKTR/L-JK-3232-4C	VRB1933	VRB2114	32	32	170	32	42	3	22		₺1.273
BKTR/L-JK-2020-5C	VRB1935	VRB2116	20	20	125	20	30	4,2	22	MGM.5	₺1.066
BKTR/L-JK-2525-5C	VRB1937	VRB2118	25	25	150	25	34	4,2	25		₺1.102
BKTR/L-JK-3232-5C	VRB1939	VRB2120	32	32	170	32	42	4,2	25		₺1.273
BKTR/L-JK-2525-6C	VRB1941	VRB2122	25	25	150	25	34	5	25	MGM.6	₺1.102
BKTR/L-JK-3232-6C	VRB1943	VRB2124	32	32	170	32	42	5	25		₺1.273
BKTR/L-JK-2525-8C	VRB1945	VRB2126	25	25	150	25	34	7	25	MGM.8	₺1.102
BKTR/L-JK-3232-8C	VRB1947	VRB2128	32	32	170	32	42	7	28		₺1.273
BKTR/L-JK-2525-3C-Tmax 30	VRB2469	VRB2470	25	25	150	25	34	2,5	30	MGM.3	₺1.284
BKTR/L-JK-2525-4C-Tmax 30	VRB2471	VRB2472	25	25	150	25	34	3	30	MGM.4	₺1.284



TaeguTec UCUNA UYGUNDUR

TEKNİK ÇİZİM / TECHNICAL DRAWING

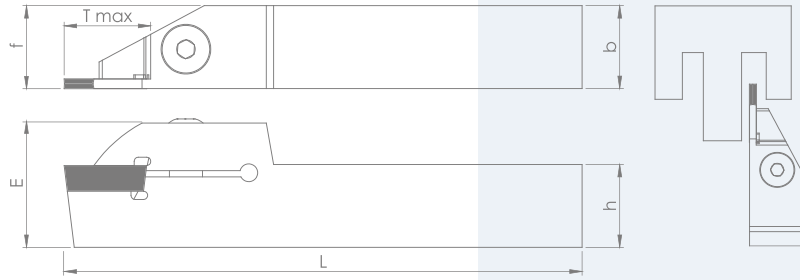
 TAKIM KODU  
ORDERING CODE

 ÜRÜN KODU  
PRODUCT CODE

 KATER ÖLÇÜLERİ  
DIMENSIONS (mm)

 KESİCİ UÇ  
INSERT

 TL FİYAT  
TL PRICE

**BKTR/L TDC**

	Sol Left	Sağ Right	h	b	L	f	E	A	Tmax		
BKTR/L-TDC-1616-2C	VRB1949	VRB2130	16	16	125	16	30	1,8	15		₺1.015
BKTR/L-TDC-2020-2C	VRB1951	VRB2132	20	20	125	20	30	1,8	15	<b>TDC.2</b>	₺1.066
BKTR/L-TDC-2525-2C	VRB1953	VRB2134	25	25	150	25	34	2,5	17		₺1.102
BKTR/L-TDC-1616-3C	VRB1955	VRB2136	16	16	125	16	30	2,5	15		₺1.015
BKTR/L-TDC-2020-3C	VRB1957	VRB2138	20	20	125	20	30	2,5	20	<b>TDC.3</b>	₺1.066
BKTR/L-TDC-2525-3C	VRB1959	VRB2140	25	25	150	25	34	2,5	22		₺1.102
BKTR/L-TDC-2020-4C	VRB1961	VRB2142	20	20	125	20	30	3	20		₺1.066
BKTR/L-TDC-2525-4C	VRB1963	VRB2144	25	25	150	25	34	3	22	<b>TDC.4</b>	₺1.102





ZCC UCUNA UYGUNDUR

TEKNİK ÇİZİM / TECHNICAL DRAWING

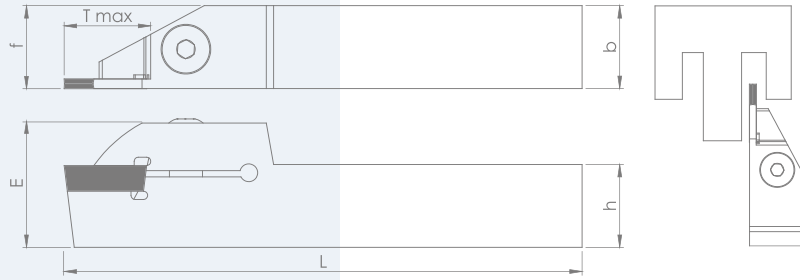
TAKIM KODU  
ORDERING CODEÜRÜN KODU  
PRODUCT CODEKATER ÖLÇÜLERİ  
DIMENSIONS (mm)KESİCİ UÇ  
INSERTTL FİYAT  
TL PRICE**BKTR/L ZCC2**

	Sol Left	Sağ Right	h	b	L	f	E	A	Tmax		
BKTR/L-ZCC2-2020-2C	VRB1965	VRB2156	20	20	125	20	30	1,6	15	<b>ZT.D2</b>	₺1.066
BKTR/L-ZCC2-2525-2C	VRB1967	VRB2158	25	25	150	25	34	16	15		₺1.102
BKTR/L-ZCC2-2020-3C	VRB1969	VRB2160	20	20	125	20	30	2,5	20	<b>ZT.D3</b>	₺1.066
BKTR/L-ZCC2-2525-3C	VRB1971	VRB2162	25	25	150	25	34	2,5	22		₺1.102
BKTR/L-ZCC2-2020-4C	VRB1973	VRB2164	20	20	125	20	30	3	20	<b>ZT.D4</b>	₺1.066
BKTR/L-ZCC2-2525-4C	VRB1975	VRB2166	25	25	150	25	34	3	22		₺1.102
BKTR/L-ZCC2-2020-5C	VRB1977	VRB2168	20	20	125	20	30	4	20	<b>ZT.D5</b>	₺1.066
BKTR/L-ZCC2-2525-5C	VRB1979	VRB2170	25	25	150	25	34	4	25		₺1.102
BKTR/L-ZCC2-2525-6C	VRB1981	VRB2172	25	25	150	25	34	5,5	25	<b>ZT.D6</b>	₺1.102



SANDVIK UCUNA UYGUNDUR

TEKNİK ÇİZİM / TECHNICAL DRAWING



TAKIM KODU ORDERING CODE	ÜRÜN KODU PRODUCT CODE	KATER ÖLÇÜLERİ DIMENSIONS (mm)	KATER ÖLÇÜLERİ DIMENSIONS (mm)							KESİCİ UÇ INSERT	TL FİYAT TL PRICE	
			Sol Left	Sağ Right	h	b	L	f	E			A
<b>BKTR/L S123</b>												
BKTR/L-S123-1212-1.5C	VRB2473	VRB2474	12	12	100	12	24	1,4	15	<b>S123.1.5</b>	₺985	
BKTR/L-S123-1616-1.5C	VRB2475	VRB2476	16	16	125	16	30	1,4	15		₺1.015	
BKTR/L-S123-2020-1.5 C	VRB2477	VRB2478	20	20	125	20	30	1,4	15		₺1.066	
BKTR/L-S123-2525-1.5C	VRB2479	VRB2480	25	25	150	25	34	1,4	15		₺1.102	
BKTR/L-S123-1212-2C	VRB2057	VRB2252	12	12	100	12	24	1,8	15	<b>S123.2</b>	₺985	
BKTR/L-S123-1616-2C	VRB2059	VRB2254	16	16	125	16	30	1,8	15		₺1.015	
BKTR/L-S123-2020-2C	VRB2061	VRB2256	20	20	125	20	30	1,8	15		₺1.066	
BKTR/L-S123-2525-2C	VRB2063	VRB2258	25	25	150	25	34	1,8	15		₺1.102	
BKTR/L-S123-3232-2C	VRB2065	VRB2260	32	32	170	32	42	1,8	15		₺1.273	
BKTR/L-S123-1212-3C	VRB2067	VRB2262	12	12	100	12	24	2,5	15	<b>S123.3</b>	₺985	
BKTR/L-S123-1616-3C	VRB2069	VRB2264	16	16	125	16	30	2,5	15		₺1.015	
BKTR/L-S123-2020-3C	VRB2071	VRB2266	20	20	125	20	30	2,5	20		₺1.066	
BKTR/L-S123-2525-3C	VRB2073	VRB2268	25	25	150	25	34	2,5	20		₺1.102	
BKTR/L-S123-3232-3C	VRB2075	VRB2270	32	32	170	32	42	2,5	20		₺1.273	
BKTR/L-S123-2020-4C	VRB2077	VRB2272	20	20	125	20	30	3	22	<b>S123.4</b>	₺1.066	
BKTR/L-S123-2525-4C	VRB2079	VRB2274	25	25	150	25	34	3	22		₺1.102	
BKTR/L-S123-3232-4C	VRB2081	VRB2276	32	32	170	32	42	3	22		₺1.273	
BKTR/L-S123-2525-5C	VRB2083	VRB2278	25	25	150	25	34	4,2	25	<b>S123.5</b>	₺1.102	
BKTR/L-S123-2525-6C	VRB2085	VRB2280	25	25	150	25	34	5	25	<b>S123.6</b>	₺1.102	
BKTR/L-S123-2525-8C	VRB2487	VRB2488	25	25	150	25	34	5	28	<b>S123.8</b>	₺1.102	



TUNGALOY UCUNA UYGUNDUR

TEKNİK ÇİZİM / TECHNICAL DRAWING

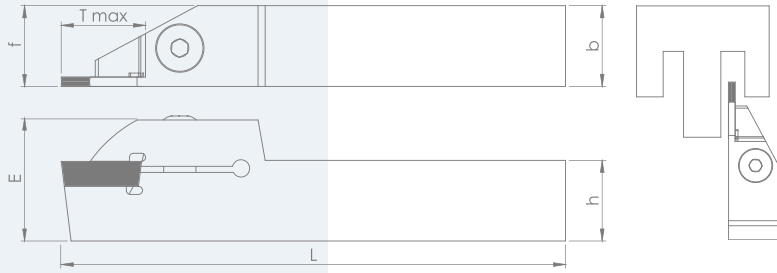
TAKIM KODU  
ORDERING CODEÜRÜN KODU  
PRODUCT CODEKATER ÖLÇÜLERİ  
DIMENSIONS (mm)KESİCİ UÇ  
INSERTTL FİYAT  
TL PRICE**BKTR/L DGM**

Sol Left	Sağ Right	h	b	L	f	E	A	Tmax
-------------	--------------	---	---	---	---	---	---	------



BKTR/L-DGM-1616-2C	VRB1983	VRB2174	16	16	125	16	30	1,8	15		₺1.015
BKTR/L-DGM-2020-2C	VRB1985	VRB2176	20	20	125	20	30	1,8	15	<b>DGM. 2</b>	₺1.066
BKTR/L-DGM-2525-2C	VRB1987	VRB2178	25	25	150	25	34	2,5	17		₺1.102
BKTR/L-DGM-1616-3C	VRB1989	VRB2180	16	16	125	16	30	2,5	15		₺1.015
BKTR/L-DGM-2020-3C	VRB1991	VRB2182	20	20	125	20	30	2,5	20	<b>DGM. 3</b>	₺1.066
BKTR/L-DGM-2525-3C	VRB1993	VRB2184	25	25	150	25	34	2,5	22		₺1.102
BKTR/L-DGM-2020-4C	VRB1995	VRB2186	20	20	125	20	30	3	20		₺1.066
BKTR/L-DGM-2525-4C	VRB1997	VRB2188	25	25	150	25	34	3	22	<b>DGM. 4</b>	₺1.102



WALTER UCUNA UYGUNDUR

TEKNİK ÇİZİM / TECHNICAL DRAWING

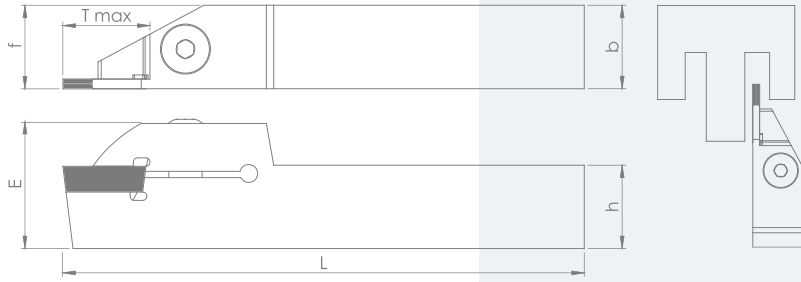
 TAKIM KODU  
ORDERING CODE

 ÜRÜN KODU  
PRODUCT CODE

 KATER ÖLÇÜLERİ  
DIMENSIONS (mm)

 KESİCİ UÇ  
INSERT

 TL FİYAT  
TL PRICE

**BKTR/L GX24**

	Sol Left	Sağ Right	h	b	L	f	E	A	Tmax
BKTR/L-GX24-1616-2C	VRB1999	VRB2190	16	16	125	16	30	1,8	15
BKTR/L-GX24-2020-2C	VRB2001	VRB2192	20	20	125	20	30	1,8	15
BKTR/L-GX24-2525-2C	VRB2003	VRB2194	25	25	150	25	34	2,5	17
BKTR/L-GX24-1616-3C	VRB2005	VRB2196	16	16	125	16	30	2,5	15
BKTR/L-GX24-2020-3C	VRB2007	VRB2198	20	20	125	20	30	2,5	20
BKTR/L-GX24-2525-3C	VRB2009	VRB2200	25	25	150	25	34	2,5	22
BKTR/L-GX24-2020-4C	VRB2011	VRB2202	20	20	125	20	30	3	20
BKTR/L-GX24-2525-4C	VRB2013	VRB2204	25	25	150	25	34	3	22

**GX24.2**
**GX24.3**
**GX24.4**

₺1.015

₺1.066

₺1.102

₺1.015

₺1.066

₺1.102

₺1.066

₺1.102



KYOCERA UCUNA UYGUNDUR

TEKNİK ÇİZİM / TECHNICAL DRAWING

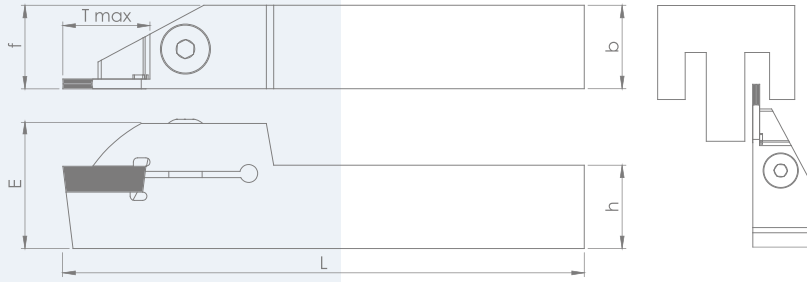
TAKIM KODU  
ORDERING CODEÜRÜN KODU  
PRODUCT CODEKATER ÖLÇÜLERİ  
DIMENSIONS (mm)KESİCİ UÇ  
INSERTTL FİYAT  
TL PRICE**BKTR/L GDM**

Sol Left	Sağ Right	h	b	L	f	E	A	Tmax
-------------	--------------	---	---	---	---	---	---	------



BKTR/L-GDM-1616-2C	VRB2015	VRB2206	16	16	125	16	30	1,8	15		₺1.015
BKTR/L-GDM-2020-2C	VRB2017	VRB2208	20	20	125	20	30	1,8	15	<b>GDM.2</b>	₺1.066
BKTR/L-GDM-2525-2C	VRB2019	VRB2210	25	25	150	25	34	2,5	17		₺1.102
BKTR/L-GDM-1616-3C	VRB2021	VRB2212	16	16	125	16	30	2,5	15		₺1.015
BKTR/L-GDM-2020-3C	VRB2023	VRB2214	20	20	125	20	30	2,5	20	<b>GDM.3</b>	₺1.066
BKTR/L-GDM-2525-3C	VRB2025	VRB2216	25	25	150	25	34	2,5	22		₺1.102
BKTR/L-GDM-2020-4C	VRB2027	VRB2218	20	20	125	20	30	3	20		₺1.066
BKTR/L-GDM-2525-4C	VRB2029	VRB2220	25	25	150	25	34	3	22	<b>GDM.4</b>	₺1.102



KORLOY UCUNA UYGUNDUR

TEKNİK ÇİZİM / TECHNICAL DRAWING

 TAKIM KODU  
ORDERING CODE

 ÜRÜN KODU  
PRODUCT CODE

 KATER ÖLÇÜLERİ  
DIMENSIONS (mm)

 KESİCİ UÇ  
INSERT

 TL FİYAT  
TL PRICE

**BKTR/L KGM**

	Sol Left	Sağ Right	h	b	L	f	E	A	Tmax		
	BKTR/L-KGM-1616-2C	VRB2031	VRB2222	16	16	125	16	30	1,8		
BKTR/L-KGM-2020-2C	VRB2033	VRB2224	20	20	125	20	30	1,8	15	<b>KGMN.2</b>	₺1.066
BKTR/L-KGM-2525-2C	VRB2035	VRB2226	25	25	150	25	34	2,5	17		₺1.102
BKTR/L-KGM-1616-3C	VRB2037	VRB2228	16	16	125	16	30	2,5	15		₺1.015
BKTR/L-KGM-2020-3C	VRB2039	VRB2230	20	20	125	20	30	2,5	20	<b>KGMN.3</b>	₺1.066
BKTR/L-KGM-2525-3C	VRB2041	VRB2232	25	25	150	25	34	2,5	22		₺1.102
BKTR/L-KGM-2020-4C	VRB2043	VRB2234	20	20	125	20	30	3	20		₺1.066
BKTR/L-KGM-2525-4C	VRB2045	VRB2236	25	25	150	25	34	3	22	<b>KGMN.4</b>	₺1.102

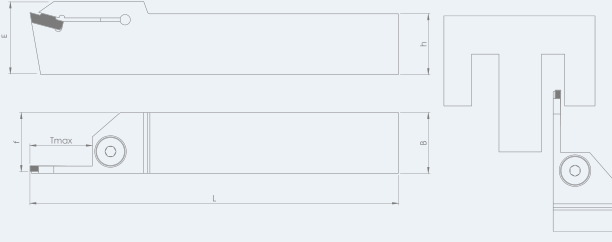

SECO UCUNA UYGUNDUR

TEKNİK ÇİZİM / TECHNICAL DRAWING

TAKIM KODU  
ORDERING CODEÜRÜN KODU  
PRODUCT CODEKATER ÖLÇÜLERİ  
DIMENSIONS (mm)KESİCİ UÇ  
INSERTTL FİYAT  
TL PRICE**BKTR LCM**

BKTR-LCM-2020-3C

VRB2238

h	b	L	f	E	A	Tmax
---	---	---	---	---	---	------

20

20

125

20

28

2,5

20



LCMF3

₺1.105

BKTR-LCM-2525-3C

VRB2240

25

25

150

25

33

2,5

20

₺1.161

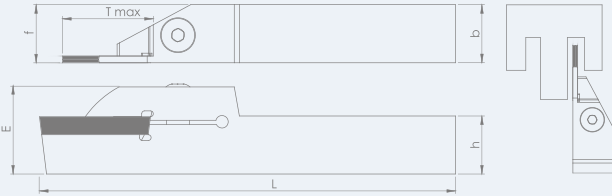

TEKNİK ÇİZİM / TECHNICAL DRAWING

TAKIM KODU  
ORDERING CODEÜRÜN KODU  
PRODUCT CODEKATER ÖLÇÜLERİ  
DIMENSIONS (mm)KESİCİ UÇ  
INSERTTL FİYAT  
TL PRICE**DMTR**

BKTR-DMTR-2525-2C

VRB2484

h	b	L	f	E	A	Tmax
---	---	---	---	---	---	------

25

25

150

25

34

1,75

35

₺1.625

BKTR-DMTR-2525-3C

VRB2485

25

25

150

25

34

2,5

35

DMTR

₺1.625

BKTR-DMTR-2525-4C

VRB2486

25

25

150

25

34

3

35

₺1.625

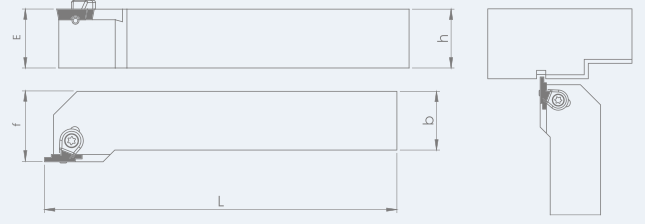

TEKNİK ÇİZİM / TECHNICAL DRAWING  
SANDVIK UCUNA UYGUNDUR

TAKIM KODU ORDERING CODE	ÜRÜN KODU PRODUCT CODE	KATER ÖLÇÜLERİ DIMENSIONS (mm)	KESİCİ UÇ INSERT	TL FİYAT TL PRICE
-----------------------------	---------------------------	-----------------------------------	---------------------	----------------------

### BKTR/L 154.91

Sol Left	Sağ Right	h	b	L	f	E	A	Tmax
-------------	--------------	---	---	---	---	---	---	------



BKTR/L-154.91-2020-3Q

VRB2047

VRB2242

20

20

125

20

25

2,5

4

154.91-3

₺1.066

BKTR/L-154.91-2525-3Q

VRB2049

VRB2244

25

25

150

25

25

2,5

4

₺1.102



TEKNİK ÇİZİM / TECHNICAL DRAWING

TAKIM KODU ORDERING CODE	ÜRÜN KODU PRODUCT CODE	KATER ÖLÇÜLERİ DIMENSIONS (mm)	KESİCİ UÇ INSERT	TL FİYAT TL PRICE
-----------------------------	---------------------------	-----------------------------------	---------------------	----------------------

### BKTR R390

h	b	L	f	E	A	Tmax
---	---	---	---	---	---	------



BKTR/L-R390-2525-2C (1.9 2.9)

VRB2481

25

25

150

25

25

1,8

6

₺1.674

BKTR/L-R390-2525-3C (2.9 3.9)

VRB2482

25

25

150

25

25

3

6

R390 HRN

₺1.674

BKTR/L-R390-2525-4C (3.9 4.9)

VRB2483

25

25

150

25

25

4

6

₺1.674





TEKNİK ÇİZİM / TECHNICAL DRAWING

TAKIM KODU  
ORDERING CODEÜRÜN KODU  
PRODUCT CODEKATER ÖLÇÜLERİ  
DIMENSIONS (mm)KESİCİ UÇ  
INSERTTL FİYAT  
TL PRICE

## PASO

		f	h	b	L	L1	
PASO - 6x8	VRB2282	32	25	16	150	50	6x6-8x8
PASO - 8x10	VRB2284	34	25	16	150	50	8x8-10x10
PASO - 10x12	VRB2286	36	25	16	150	50	10x10-12x12
PASO - 12x14	VRB2288	38	25	16	150	50	12x12-14x14



BPV M8

₺1.119

₺1.119

₺1.119

₺1.273



TEKNİK ÇİZİM / TECHNICAL DRAWING

TAKIM KODU  
ORDERING CODEÜRÜN KODU  
PRODUCT CODEKATER ÖLÇÜLERİ  
DIMENSIONS (mm)KESİCİ UÇ  
INSERTTL FİYAT  
TL PRICE

## KESME

		f	h	b	L	L1	
KESME - 1/2	VRB2290	24	25	16	130	50	12,7x3-4
KESME - 5/8	VRB2292	24	25	16	130	50	15,8x3-4
KESME - 3/4	VRB2294	30	25	16	150	50	19x3-4,5
KESME - 7/8	VRB2296	35	25	16	150	50	22x4-5
KESME - 1	VRB2298	35	25	16	150	50	25x4-5



BBV M8

₺845

₺845

₺891

₺923

₺1.160

www.vorgen.com

**VORGEN®**

# DIŞ ÇAP ALIN KANAL AÇMA KATERLERİ

FACE EXTERNAL GROOVING TOOL HOLDERS

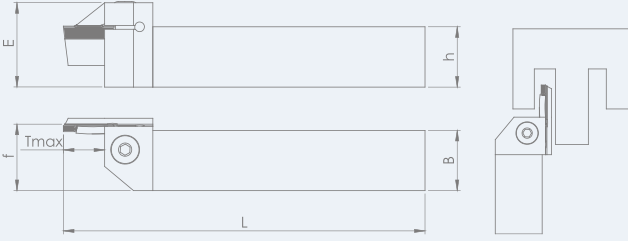

**TEKNİK ÇİZİM / TECHNICAL DRAWING**  
**KORLOY UCUNA UYGUNDUR**

TAKIM KODU ORDERING CODE	ÜRÜN KODU PRODUCT CODE	KATER ÖLÇÜLERİ DIMENSIONS (mm)	KESİCİ UÇ INSERT	TL FİYAT TL PRICE									
<b>BKATR/L JK</b>	<b>Sol Left</b>	<b>Sağ Right</b>	<b>h</b>	<b>b</b>	<b>L</b>	<b>f</b>	<b>E</b>	<b>A</b>	<b>Tmax</b>	<b>Dmin</b>	<b>Dmax</b>		
BKATR/L-JK-2525-(34-45)-2C	VRB2087	VRB2300	25	25	150	26,5	34	1,8	15	34	45	<b>MGM.2</b>	₺1.504
BKATR/L-JK-2525-(39-55)-2C	VRB2089	VRB2302	25	25	150	26,5	34	1,8	15	39	55		₺1.504
BKATR/L-JK-2525-(34-45)-3C	VRB2091	VRB2304	25	25	150	26,5	34	2,2	18	34	45		₺1.504
BKATR/L-JK-2525-(39-55)-3C	VRB2093	VRB2306	25	25	150	26,5	34	2,2	18	39	55		₺1.504
BKATR/L-JK-2525-(49-80)-3C	VRB2095	VRB2308	25	25	150	26,5	34	2,2	18	49	80	<b>MGM.3</b>	₺1.504
BKATR/L-JK-2525-(70-110)-3C	VRB2097	VRB2310	25	25	150	26,5	34	2,2	18	70	110		₺1.504
BKATR/L-JK-2525-(100-150)-3C	VRB2099	VRB2312	25	25	150	26,5	34	2,2	18	100	150		₺1.504



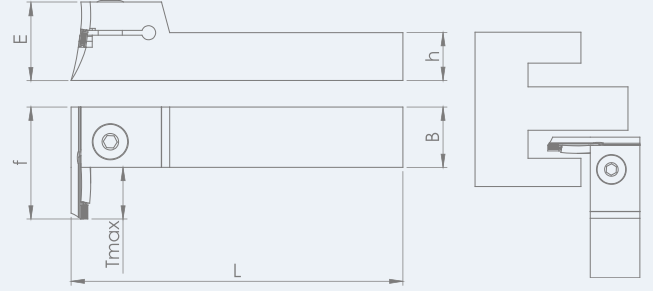

TEKNİK ÇİZİM / TECHNICAL DRAWING

TAKIM KODU ORDERING CODE	ÜRÜN KODU PRODUCT CODE	KATER ÖLÇÜLERİ DIMENSIONS (mm)	KESİCİ UÇ INSERT	TL FİYAT TL PRICE								
<b>BKLTR/L JK</b>	<b>Sol</b> Left	<b>Sağ</b> Right	<b>h</b>	<b>b</b>	<b>L</b>	<b>f</b>	<b>E</b>	<b>A</b>	<b>Tmax</b>	<b>Dmin</b>	<b>Dmax</b>	
BKLTR/L-JK-2525-(25-35)-3C	VRB2101	VRB2314	25	25	150	37	34	2,2	12	25	35	₺1.615
BKLTR/L-JK-2525-(35-55)-3C	VRB2103	VRB2316	25	25	150	37	34	2,2	12	35	55	<b>MGM.3</b> ₺1.615
BKLTR/L-JK-2525-(50-75)-3C	VRB2105	VRB2318	25	25	150	37	34	2,2	12	50	75	₺1.615
BKLTR/L-JK-2525-(70-105)-4C	VRB2107	VRB2320	25	25	150	37	34	3,2	14	70	105	<b>MGM.4</b> ₺1.615
BKLTR/L-JK-2525-(100-205)-4C	VRB2109	VRB2322	25	25	150	37	34	3,2	14	100	205	₺1.615

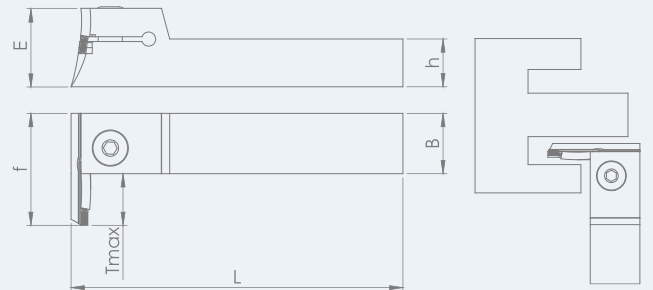
 TEKNİK ÇİZİM / TECHNICAL DRAWING  
WALTER ÜÇUNA UYGUNDUR

TAKIM KODU ORDERING CODE	ÜRÜN KODU PRODUCT CODE	KATER ÖLÇÜLERİ DIMENSIONS (mm)	KESİCİ UÇ INSERT	TL FİYAT TL PRICE								
<b>BKLTR/L GX24</b>	<b>Sol</b> Left	<b>Sağ</b> Right	<b>h</b>	<b>b</b>	<b>L</b>	<b>f</b>	<b>E</b>	<b>A</b>	<b>Tmax</b>	<b>Dmin</b>	<b>Dmax</b>	
BKLTR/L-GX24-2525-(25-35)-3C	VRB2111	VRB2324	25	25	150	37	34	2,2	12	25	35	₺1.615
BKLTR/L-GX24-2525-(35-55)-3C	VRB2113	VRB2326	25	25	150	37	34	2,2	12	35	55	<b>GX24.3</b> ₺1.615
BKLTR/L-GX24-2525-(50-75)-3C	VRB2115	VRB2328	25	25	150	37	34	2,2	12	50	75	₺1.615
BKLTR/L-GX24-2525-(70-105)-4C	VRB2117	VRB2330	25	25	150	37	34	3,2	14	70	105	<b>GX24.4</b> ₺1.615
BKLTR/L-GX24-2525-(100-205)-4C	VRB2119	VRB2332	25	25	150	37	34	3,2	14	100	205	₺1.615

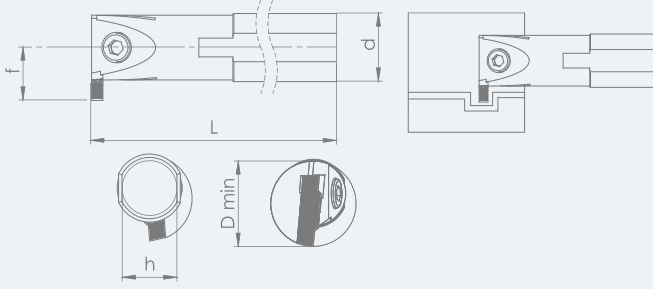

**TEKNİK ÇİZİM / TECHNICAL DRAWING**  
HORN UCUNA UYGUNDUR



**TAKIM KODU**  
ORDERING CODE

**ÜRÜN KODU**  
PRODUCT CODE

**KATER ÖLÇÜLERİ**  
DIMENSIONS (mm)

**KESİCİ UÇ**  
INSERT

**TL FİYAT**  
TL PRICE

### BKTI-R/L KH

	Sol Left	Sağ Right	L	d	f	h	Tmax		
BKTI-R/L-KH-S16Q-2C	VRB2121	VRB2334	180	16	11	14			₺863
BKTI-R/L-KH-S20R-2C	VRB2123	VRB2336	200	20	13	18	4	<b>S224.2</b>	₺996
BKTI-R/L-KH-S25R-2C	VRB2125	VRB2338	200	25	17	23			₺1.066
BKTI-R/L-KH-S20R-3C	VRB2127	VRB2340	200	20	13	18	6	<b>S224.3</b>	₺996
BKTI-R/L-KH-S25R-3C	VRB2129	VRB2342	200	25	17	23			₺1.066
BKTI-R/L-KH-S20R-4C	VRB2131	VRB2344	200	20	13	18	6	<b>S224.4</b>	₺996
BKTI-R/L-KH-S25R-4C	VRB2133	VRB2346	200	25	17	23			₺1.066
BKTI-R/L-KH-S25R-5C	VRB2135	VRB2348	200	25	17	23	6	<b>S224.5</b>	₺1.066

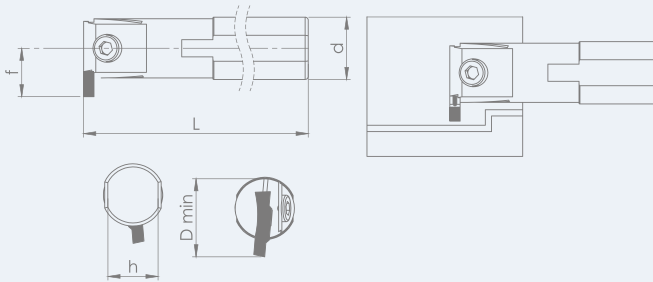

**TEKNİK ÇİZİM / TECHNICAL DRAWING**  
ISCAR UCUNA UYGUNDUR



**TAKIM KODU**  
ORDERING CODE

**ÜRÜN KODU**  
PRODUCT CODE

**KATER ÖLÇÜLERİ**  
DIMENSIONS (mm)

**KESİCİ UÇ**  
INSERT

**TL FİYAT**  
TL PRICE

### BKTI-R/L TGM3

	Sol Left	Sağ Right	L	d	f	h	Tmax		
BKTI-R/L-TGM3-S16Q -3C	VRB2241	VRB2454	180	16	12	14,5	6	<b>TGM.3</b>	₺1.015
BKTI-R/L-TGM3-S20R -3C	VRB2243	VRB2456	200	20	14,2	18,5			₺1.139

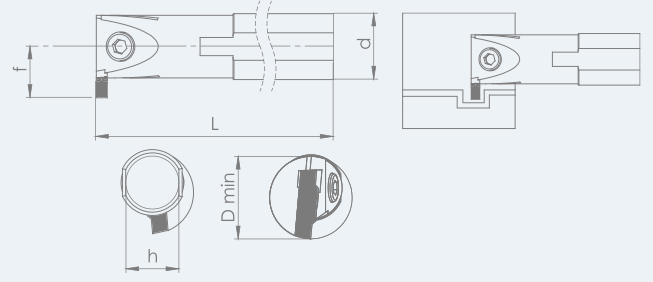

TEKNİK ÇİZİM / TECHNICAL DRAWING

TAKIM KODU ORDERING CODE	ÜRÜN KODU PRODUCT CODE	KATER ÖLÇÜLERİ DIMENSIONS (mm)	KESİCİ UÇ INSERT	TL FİYAT TL PRICE
-----------------------------	---------------------------	-----------------------------------	---------------------	----------------------

**BKTI-R/L JK**

	Sol Left	Sağ Right	L	d	f	h	Tmax
BKTI-R/L-JK-16Q-1.5C	VRB2488	VRB2489	180	16	11	14	
BKTI-R/L-JK-S16Q-2C	VRB2137	VRB2350	180	16	11	14	4
BKTI-R/L-JK-S20R-2C	VRB2139	VRB2352	200	20	13	18	
BKTI-R/L-JK-S25R-2C	VRB2141	VRB2354	200	25	17	23	
BKTI-R/L-JK-S32S-2C	VRB2143	VRB2356	250	32	17	30	4
BKTI-R/L-JK-S16Q-3C	VRB2145	VRB2358	180	16	11	14	8
BKTI-R/L-JK-S20R-3C	VRB2147	VRB2360	200	20	13	18	6
BKTI-R/L-JK-S25R-3C	VRB2149	VRB2362	200	25	17	23	
BKTI-R/L-JK-S32S-3C	VRB2151	VRB2364	250	32	17	30	6
BKTI-R/L-JK-S40T-3C	VRB2153	VRB2366	300	40	26	37,5	
BKTI-R/L-JK-S20R-4C	VRB2155	VRB2368	200	20	13	18	6
BKTI-R/L-JK-S25R-4C	VRB2157	VRB2370	200	25	17	23	
BKTI-R/L-JK-S32S-4C	VRB2159	VRB2372	250	32	17	30	6
BKTI-R/L-JK-S40T-4C	VRB2161	VRB2374	300	40	26	37,5	
BKTI-R/L-JK-S25R-5C	VRB2163	VRB2376	200	25	17	23	7
BKTI-R/L-JK-S32S-5C	VRB2165	VRB2378	250	32	17	30	7
BKTI-R/L-JK-S40T-5C	VRB2167	VRB2380	250	40	26	37,5	
BKTI-R/L-JK-S25R-6C	VRB2169	VRB2382	200	25	17	23	8
BKTI-R/L-JK-S32S-6C	VRB2171	VRB2384	250	32	17	30	8
BKTI-R/L-JK-S40T-6C	VRB2173	VRB2386	300	40	26	37,5	

**MGM.2**
**MGM.3**
**MGM.4**
**MGM.5**
**MGM.6**

₺863

₺863

₺996

₺1.066

₺1.139

₺863

₺996

₺1.066

₺1.139

₺1.859

₺996

₺1.066

₺1.139

₺1.859

₺1.066

₺1.139

₺1.859

₺1.066

₺1.139

₺1.859

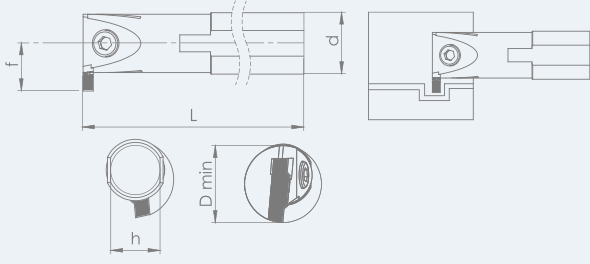
**TEKNİK ÇİZİM / TECHNICAL DRAWING**  
**HORN UCUNA UYGUNDUR**

TAKIM KODU ORDERING CODE	ÜRÜN KODU PRODUCT CODE	KATER ÖLÇÜLERİ DIMENSIONS (mm)	KESİCİ UÇ INSERT	TL FİYAT TL PRICE					
<b>BKTI-R/L S123</b>	<b>Sol Left</b>	<b>Sağ Right</b>	<b>L</b>	<b>d</b>	<b>f</b>	<b>h</b>	<b>Tmax</b>		
BKTI-R/L-S123-S16Q -2C	VRB2175	VRB2388	180	16	11	14			₺863
BKTI-R/L-S123-S20R -2C	VRB2177	VRB2390	200	20	13	18	4	<b>S123.2</b>	₺996
BKTI-R/L-S123-S25R -2C	VRB2179	VRB2392	200	25	17	23			₺1.066
BKTI-R/L-S123-S32S -2C	VRB2181	VRB2394	250	32	17	30	4		₺1.139
BKTI-R/L-S123-S16Q -3C	VRB2183	VRB2396	180	16	11	14		<b>S123.3</b>	₺863
BKTI-R/L-S123-S20R -3C	VRB2185	VRB2398	200	20	13	18	5		₺996
BKTI-R/L-S123-S25R -3C	VRB2187	VRB2400	200	25	17	23			₺1.066
BKTI-R/L-S123-S32S -3C	VRB2189	VRB2402	250	32	17	30	5	<b>S123.4</b>	₺1.139
BKTI-R/L-S123-S40T -3C	VRB2191	VRB2404	300	40	26,5	37,5			₺1.859
BKTI-R/L-S123-S20R -4C	VRB2193	VRB2406	190	20	13	18	7		₺996
BKTI-R/L-S123-S25R -4C	VRB2195	VRB2408	200	25	17	23		<b>S123.5</b>	₺1.066
BKTI-R/L-S123-S32S -4C	VRB2197	VRB2410	250	32	17	30	7		₺1.139
BKTI-R/L-S123-S40T -4C	VRB2199	VRB2412	300	40	26,5	37,5			₺1.859
BKTI-R/L-S123-S20R -5C	VRB2201	VRB2414	200	20	13	18	8	<b>S123.5</b>	₺996
BKTI-R/L-S123-S25R -5C	VRB2203	VRB2416	200	25	17	23			₺1.066
BKTI-R/L-S123-S32S -5C	VRB2205	VRB2418	250	32	17	30	8		₺1.139
BKTI-R/L-S123-S40T -5C	VRB2207	VRB2420	300	40	26,5	37,5			₺1.859

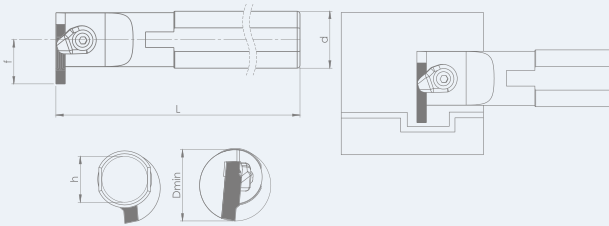
**TEKNİK ÇİZİM / TECHNICAL DRAWING**  
**ISCAR UCUNA UYGUNDUR**

TAKIM KODU ORDERING CODE	ÜRÜN KODU PRODUCT CODE	KATER ÖLÇÜLERİ DIMENSIONS (mm)	KESİCİ UÇ INSERT	TL FİYAT TL PRICE					
<b>BKTI-R/L 154.91</b>	<b>Sol Left</b>	<b>Sağ Right</b>	<b>L</b>	<b>d</b>	<b>f</b>	<b>h</b>	<b>Tmax</b>		
BKTI-R/L-154.91-S16Q -3Q	VRB2209	VRB2422	180	16	11	14			₺923
BKTI-R/L-154.91-S20R -3Q	VRB2211	VRB2424	200	20	13	18	4	<b>154.91.3</b>	₺1.015
BKTI-R/L-154.91-S25R -3Q	VRB2213	VRB2426	200	25	17	23			₺1.119

Strong and Precise Tools

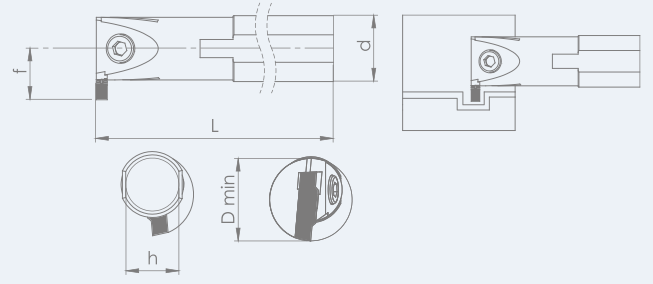

**TEKNİK ÇİZİM / TECHNICAL DRAWING**

TAKIM KODU ORDERING CODE	ÜRÜN KODU PRODUCT CODE	KATER ÖLÇÜLERİ DIMENSIONS (mm)	KESİCİ UÇ INSERT	TL FİYAT TL PRICE
-----------------------------	---------------------------	-----------------------------------	---------------------	----------------------

**BKTI-R/L IS**

Sol Left	Sağ Right	L	d	f	h	Tmax
-------------	--------------	---	---	---	---	------

BKTI-R/L-IS-S20R -2C	VRB2215	VRB2428	200	20	13	18	5	DGN 2	₺996
BKTI-R/L-IS-S25R -2C	VRB2217	VRB2430	200	25	17	23	5		₺1.066
BKTI-R/L-IS-S20R -3C	VRB2219	VRB2432	200	20	13	18	6	DGN 3	₺996
BKTI-R/L-IS-S25R -3C	VRB2221	VRB2434	200	25	17	23	6		₺1.066



**DGN 2**

₺996

₺1.066

₺996

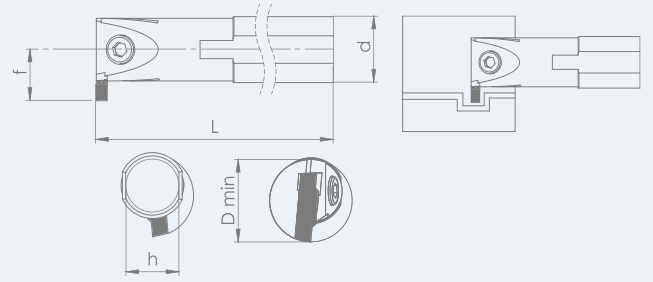
₺1.066

**TEKNİK ÇİZİM / TECHNICAL DRAWING**

TAKIM KODU ORDERING CODE	ÜRÜN KODU PRODUCT CODE	KATER ÖLÇÜLERİ DIMENSIONS (mm)	KESİCİ UÇ INSERT	TL FİYAT TL PRICE
-----------------------------	---------------------------	-----------------------------------	---------------------	----------------------

**BKTI-R/L BH**

Sol Left	Sağ Right	L	d	f	h	Tmax
-------------	--------------	---	---	---	---	------

BKTI-R/L -BH-S25R-3C	VRB2223	VRB2436	200	25	17	23	7	S 229-3	₺1.066
BKTI-R/L -BH-S32S-3C	VRB2225	VRB2438	250	32	22	32			₺1.139
BKTI-R/L -BH-S40T-3C	VRB2227	VRB2440	300	40	26,5	37,5	7	S 229-4	₺1.859
BKTI-R/L -BH-S25R-4C	VRB2229	VRB2442	200	25	17	23			₺1.066
BKTI-R/L -BH-S32S-4C	VRB2231	VRB2444	250	32	22	32	7	S 229-4	₺1.139
BKTI-R/L -BH-S40T-4C	VRB2233	VRB2446	300	40	26,5	37,5	7	S 229-5	₺1.859
BKTI-R/L -BH-S25R-5C	VRB2235	VRB2448	200	25	17	23			₺1.066
BKTI-R/L -BH-S32S-5C	VRB2237	VRB2450	250	32	22	32	7	S 229-5	₺1.139
BKTI-R/L -BH-S40T-5C	VRB2239	VRB2452	300	40	26,5	37,5	7	S 229-5	₺1.859

**S 229-3**

₺1.066

₺1.139

₺1.859

₺1.066

₺1.139

₺1.859

₺1.066

₺1.139

₺1.859



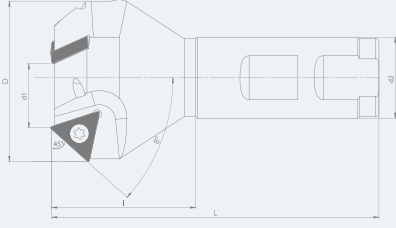

TEKNİK ÇİZİM / TECHNICAL DRAWING  
ISCAR UCUNA UYGUNDUR



TAKIM KODU ORDERING CODE	ÜRÜN KODU PRODUCT CODE	KATER ÖLÇÜLERİ DIMENSIONS (mm)				KESİCİ UÇ INSERT	TL FİYAT TL PRICE	
<b>SPTC</b>	<b>45°</b>	<b>D</b>	<b>d1</b>	<b>d2</b>	<b>L</b>	KESİCİ UÇ ADET INSERT QTY		
SPTC11-4-15x1-16-100	VRT2457	15	4	16	100	1	TC.. 1102	₺787
SPTC16-4-23x1-16-100	VRT2458	23	4	16	100	1		₺811
SPTC16-10-31x2-16-100	VRT2459	31	10	16	100	2		₺837
SPTC16-14-35x2-20-100	VRT2460	35	14	20	100	2	TC.. 16T3	₺861
SPTC16-22-43x3-25-100	VRT2461	43	22	25	100	3		₺871
SPTC16-32-53x3-25-100	VRT2462	53	32	25	100	3		₺902



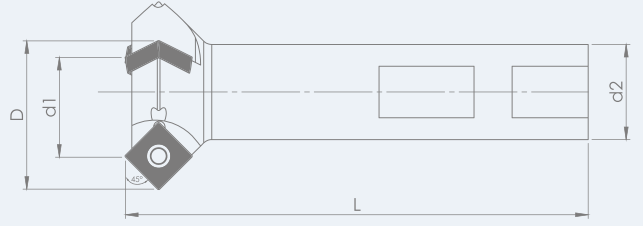

TEKNİK ÇİZİM / TECHNICAL DRAWING

TAKIM KODU ORDERING CODE	ÜRÜN KODU PRODUCT CODE	KATER ÖLÇÜLERİ DIMENSIONS (mm)	KESİCİ UÇ INSERT	TL FİYAT TL PRICE
<b>SPSC</b> 45°		<b>D</b> <b>d1</b> <b>d2</b> <b>L</b>	<b>KESİCİ UÇ ADET</b> INSERT QTY	
SPSC09-4-13x1 16 120	VRT2463	13 4 16 120	1	₺837
SPSC09-19-31x3 20 120	VRT2464	31 19 20 120	3 <b>SC.. 09 T3</b>	₺884
SPSC09-20-41x3 25 120	VRT2465	41 20 25 120	3	₺982
SPSC12-35-50x4 25 120	VRT2466	50 35 25 120	4 <b>SC.. 1204</b>	₺1.082

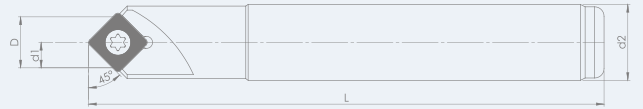

TEKNİK ÇİZİM / TECHNICAL DRAWING

TAKIM KODU ORDERING CODE	ÜRÜN KODU PRODUCT CODE	KATER ÖLÇÜLERİ DIMENSIONS (mm)	KESİCİ UÇ INSERT	TL FİYAT TL PRICE
<b>SPSP</b> 45°		<b>D</b> <b>d1</b> <b>d2</b> <b>L</b>	<b>KESİCİ UÇ ADET</b> INSERT QTY	
SPSP09-4-16x1 16 110	VRT2467	16 4 16 110	1 <b>SP.. 09 03</b>	₺924



[www.vorgen.com](http://www.vorgen.com)

**VORGEN®**

# FREZE TAKIMLARI

MILLING TOOLS



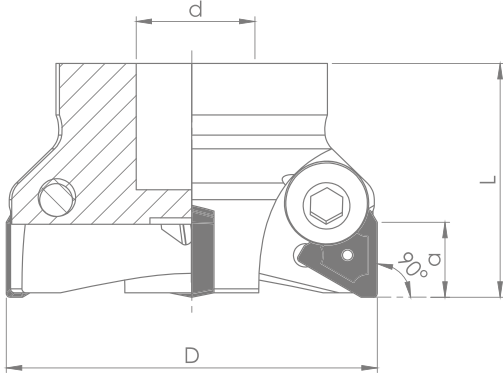
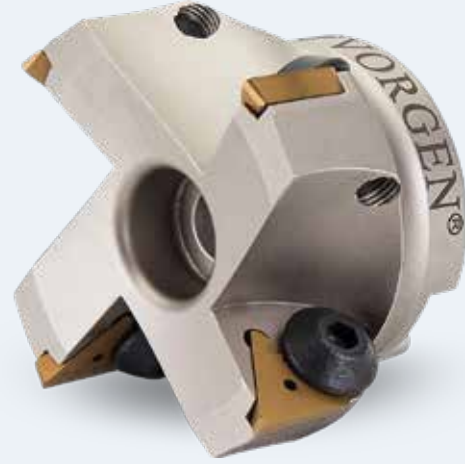

TEKNİK ÇİZİM / TECHNICAL DRAWING



TAKIM KODU ORDERING CODE	ÜRÜN KODU PRODUCT CODE	KATER ÖLÇÜLERİ DIMENSIONS (mm)				KESİCİ UÇ INSERT	TL FİYAT TL PRICE
		D	d	L	A	KESİCİ UÇ ADET INSERT QTY	
<b>VRF90S TP22</b>	<b>90°</b>						
VRF90S-TP22-D063-d22-Z04	VRT2468	63	22	40	20	4	₺2.129
VRF90S-TP22-D080-d27-Z05	VRT2469	80	27	50	20	5	₺2.282
VRF90S-TP22-D100-d32-Z06	VRT2470	100	32	50	20	6	₺2.553
VRF90S-TP22-D125-d40-Z07	VRT2471	125	40	62	20	7	₺3.494
VRF90S-TP22-D160-d40-Z08	VRT2472	160	40	62	20	8	₺4.597
VRF90-TP22-D063-d22-Z04	VRT2473	63	22	40	20	4	₺1.279
VRF90-TP22-D080-d27-Z05	VRT2474	80	27	50	20	5	₺1.344
VRF90-TP22-D100-d32-Z06	VRT2475	100	32	50	20	6	₺2.046
VRF90-TP22-D125-d40-Z07	VRT2476	125	40	62	20	7	₺2.665
VRF90-TP22-D160-d40-Z08	VRT2477	160	40	62	20	8	₺3.494

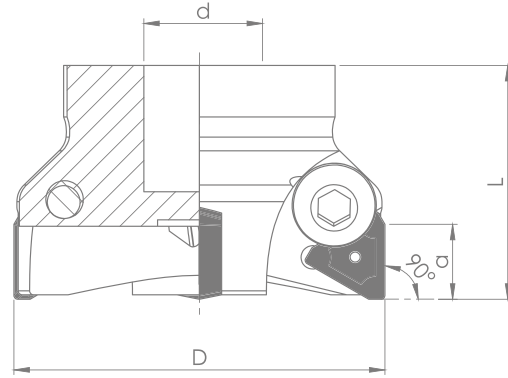

TEKNİK ÇİZİM / TECHNICAL DRAWING

TAKIM KODU ORDERING CODE	ÜRÜN KODU PRODUCT CODE	KATER ÖLÇÜLERİ DIMENSIONS (mm)				KESİCİ UÇ INSERT	TL FİYAT TL PRICE
<b>VRF90S TP16</b>	<b>90°</b>	<b>D</b>	<b>d</b>	<b>L</b>	<b>A</b>	<b>KESİCİ UÇ ADET INSERT QTY</b>	
VRF90S-TP16-D080-d27-Z05	VRT2478	80	27	50	14	5	TPKN 1603
VRF90S-TP16-D100-d32-Z06	VRT2479	100	32	50	14	6	TPKN 1603
VRF90-TP16-D042-d16-Z03	VRT2480	42	16	45	14	3	TPKN 1603
VRF90-TP16-D050-d22-Z03	VRT2481	50	22	45	14	3	TPKN 1603
VRF90-TP16-D063-d22-Z03	VRT2482	63	22	45	14	3	TPKN 1603
VRF90-TP16-D063-d22-Z04	VRT2483	63	22	45	14	4	TPKN 1603
VRF90-TP16-D080-d27-Z05	VRT2484	80	27	50	14	5	TPKN 1603
VRF90-TP16-D100-d32-Z06	VRT2485	100	32	50	14	6	TPKN 1603

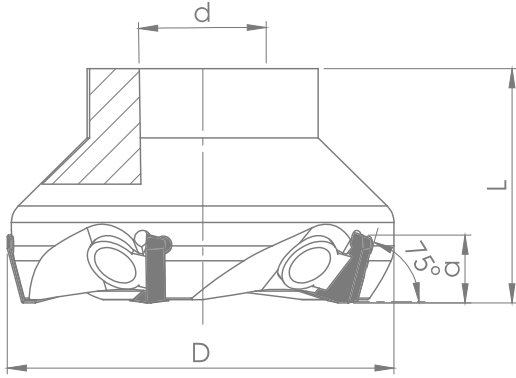

TEKNİK ÇİZİM / TECHNICAL DRAWING



TAKIM KODU ORDERING CODE	ÜRÜN KODU PRODUCT CODE	KATER ÖLÇÜLERİ DIMENSIONS (mm)	KESİCİ UÇ INSERT	TL FİYAT TL PRICE
-----------------------------	---------------------------	-----------------------------------	---------------------	----------------------

**VRF75 SP12 75°**

D	d	L	A	KESİCİ UÇ ADET INSERT QTY
50	22	40	5	4
63	22	40	5	5
80	27	50	5	6
100	32	50	5	8
125	40	62	5	10
160	40	62	5	12
200	60	62	5	14
300	60	65	5	20



SPKN  
1204

₺1.700
₺1.881
₺2.271
₺2.753
₺3.753
₺4.823
₺7.597
₺14.476

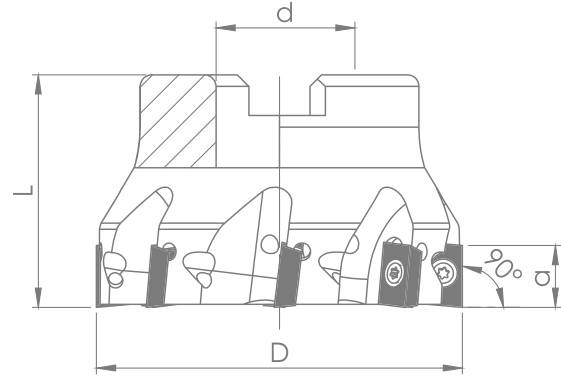

TEKNİK ÇİZİM / TECHNICAL DRAWING

**TAKIM KODU**  
ORDERING CODE

**ÜRÜN KODU**  
PRODUCT CODE

**KATER ÖLÇÜLERİ**  
DIMENSIONS (mm)

**KESİCİ UÇ**  
INSERT

**TL FİYAT**  
TL PRICE

**VRF90 AP16** 90°

		D	d	L	A	KESİCİ UÇ ADET INSERT QTY	
VRF90-AP16-D040-d16-Z04	VRT2494	40	16	40	13	4	
VRF90-AP16-D050-d22-Z05	VRT2495	50	22	40	13	5	
VRF90-AP16-D063-d22-Z06	VRT2496	63	22	40	13	6	
VRF90-AP16-D080-d27-Z07	VRT2497	80	27	50	13	7	
VRF90-AP16-D100-d32-Z08	VRT2498	100	32	50	13	8	
VRF90-AP16-D125-d40-Z09	VRT2499	125	40	60	13	9	
VRF90-AP16-D160-d40-Z10	VRT2500	160	40	60	13	10	

**APKT**  
**1604**

₺1.195

₺1.504

₺1.780

₺2.041

₺2.457

₺3.639

₺4.748

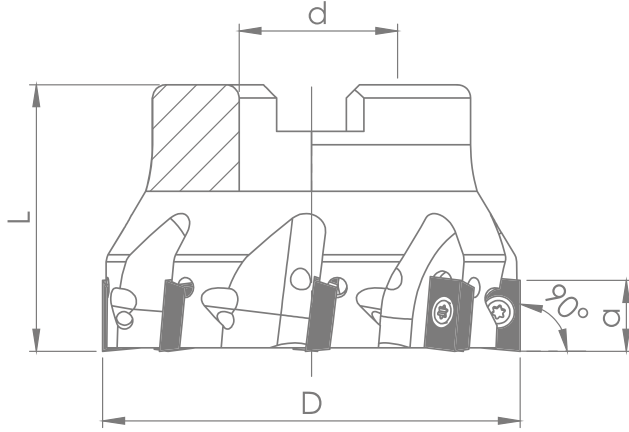

TEKNİK ÇİZİM / TECHNICAL DRAWING



TAKIM KODU ORDERING CODE	ÜRÜN KODU PRODUCT CODE	KATER ÖLÇÜLERİ DIMENSIONS (mm)	KESİCİ UÇ INSERT	TL FİYAT TL PRICE
-----------------------------	---------------------------	-----------------------------------	---------------------	----------------------

**VRF90 AP10 90°**

D	d	L	A	KESİCİ UÇ ADET INSERT QTY
---	---	---	---	------------------------------

VRF90-AP10-D040-d16-Z06	VRT2505	40	16	40	8	6
VRF90-AP10-D050-d22-Z07	VRT2506	50	22	40	8	7
VRF90-AP10-D063-d22-Z08	VRT2507	63	22	40	8	8
VRF90-AP10-D080-d27-Z10	VRT2508	80	27	50	8	10
VRF90-AP10-D100-d32-Z12	VRT2509	100	32	50	8	12



**APKT  
1003**

₺1.589

₺1.700

₺2.113

₺2.282

₺2.755



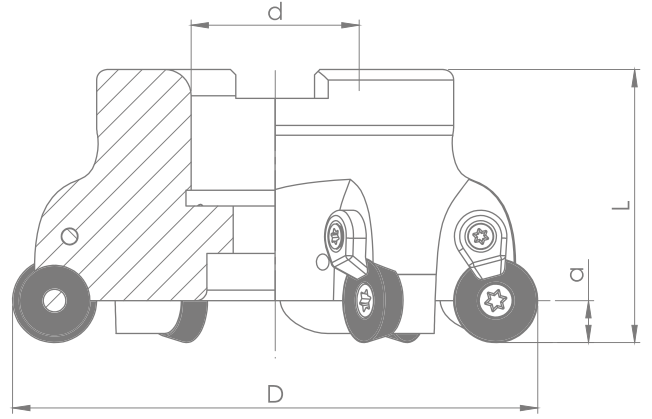

TEKNİK ÇİZİM / TECHNICAL DRAWING

**TAKIM KODU**  
ORDERING CODE



**ÜRÜN KODU**  
PRODUCT CODE

**KATER ÖLÇÜLERİ**  
DIMENSIONS (mm)

**KESİCİ UÇ**  
INSERT

**TL FİYAT**  
TL PRICE

**VRF RD10**

	D	d	L	A	KESİCİ UÇ ADET INSERT QTY		
VRF-RD1003-D040-d16-Z04	40	16	40	5	4		₺1.195
VRF-RD1003-D050-d22-Z05	50	22	40	5	5		₺1.460
VRF-RD1003-D063-d22-Z06	63	22	40	5	6	<b>RD.. 10 03</b>	₺1.888
VRF-RD1003-D080-d27-Z07	80	27	50	5	7		₺2.067
VRF-RD1003-D100-d32-Z08	100	32	50	5	8		₺2.430

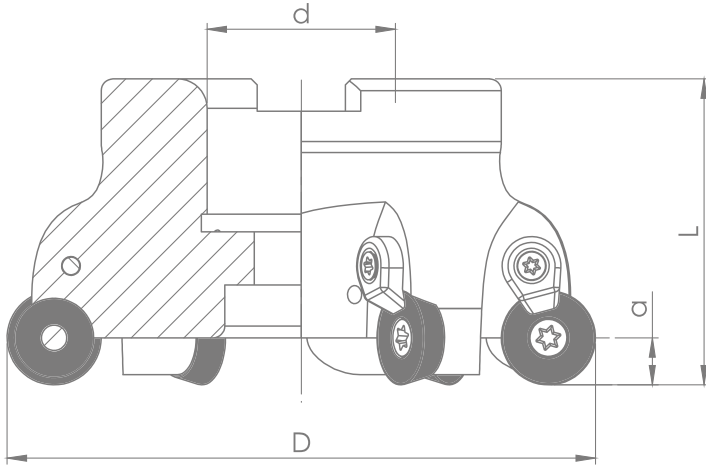

TEKNİK ÇİZİM / TECHNICAL DRAWING



**TAKIM KODU**  
ORDERING CODE

**ÜRÜN KODU**  
PRODUCT CODE

**KATER ÖLÇÜLERİ**  
DIMENSIONS (mm)

**KESİCİ UÇ**  
INSERT

**TL FİYAT**  
TL PRICE

**VRF RD12T03**

TAKIM KODU	ÜRÜN KODU	D	d	L	A	KESİCİ UÇ ADET INSERT QTY
VRF-RD12T03-D040-d16-Z04	VRT2515	40	16	40	6	4
VRF-RD12T03-D050-d22-Z05	VRT2516	50	22	40	6	5
VRF-RD12T03-D063-d22-Z06	VRT2517	63	22	40	6	6
VRF-RD12T03-D080-d27-Z07	VRT2518	80	27	50	6	7
VRF-RD12T03-D100-d32-Z08	VRT2519	100	32	50	6	8



**RD..**  
**12 T03**

₺1.195

₺1.460

₺1.888

₺2.067

₺2.430

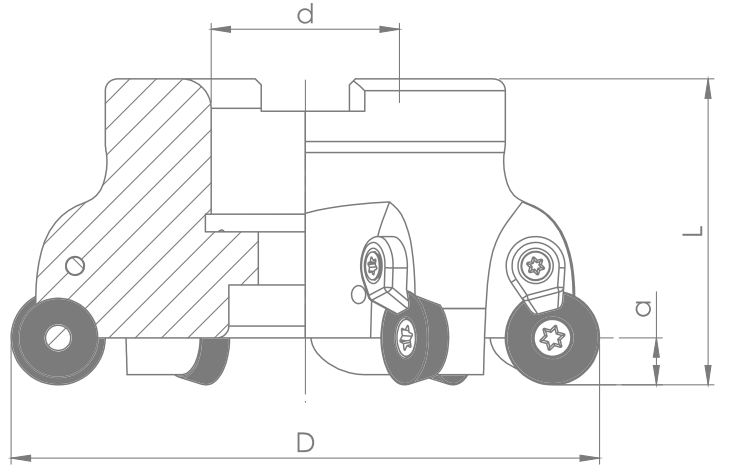

TEKNİK ÇİZİM / TECHNICAL DRAWING

**TAKIM KODU**  
ORDERING CODE

**ÜRÜN KODU**  
PRODUCT CODE

**KATER ÖLÇÜLERİ**  
DIMENSIONS (mm)

**KESİCİ UÇ**  
INSERT

**TL FİYAT**  
TL PRICE

**VRF RD1204**

	D	d	L	A	KESİCİ UÇ ADET INSERT QTY		
VRF-RD1204-D040-d16-Z04	40	16	40	6	4		₺1.195
VRF-RD1204-D050-d22-Z05	50	22	40	6	5		₺1.460
VRF-RD1204-D063-d22-Z06	63	22	40	6	6	<b>RD..</b> <b>12 04</b>	₺1.888
VRF-RD1204-D080-d27-Z07	80	27	50	6	7		₺2.067
VRF-RD1204-D100-d32-Z08	100	32	50	6	8		₺2.430

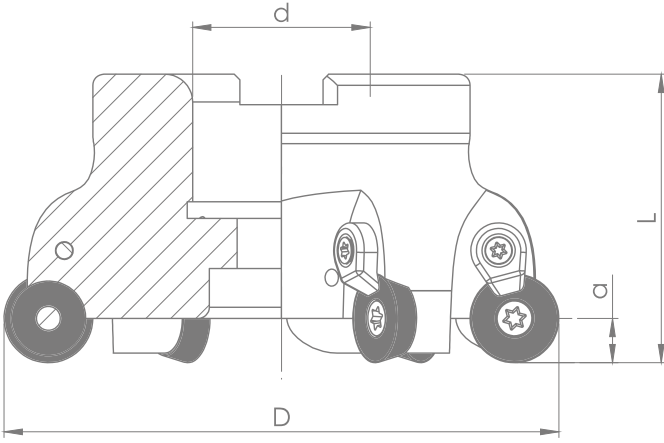

TEKNİK ÇİZİM / TECHNICAL DRAWING

TAKIM KODU  
ORDERING CODE

ÜRÜN KODU  
PRODUCT CODE

KATER ÖLÇÜLERİ  
DIMENSIONS (mm)

KESİCİ UÇ  
INSERT

TL FİYAT  
TL PRICE

**VRF RD1604**

TAKIM KODU ORDERING CODE	ÜRÜN KODU PRODUCT CODE	D	d	L	A	KESİCİ UÇ ADET INSERT QTY
VRF-RD1604-D063-d22-Z04	VRT2525	63	22	45	8	4
VRF-RD1604-D080-d27-Z05	VRT2526	80	27	50	8	5
VRF-RD1604-D100-d32-Z06	VRT2527	100	32	50	8	6
VRF-RD1604-D125-d40-Z07	VRT2528	125	40	65	8	7



RD..  
16 04

₺1.790

₺2.129

₺2.387

₺3.323

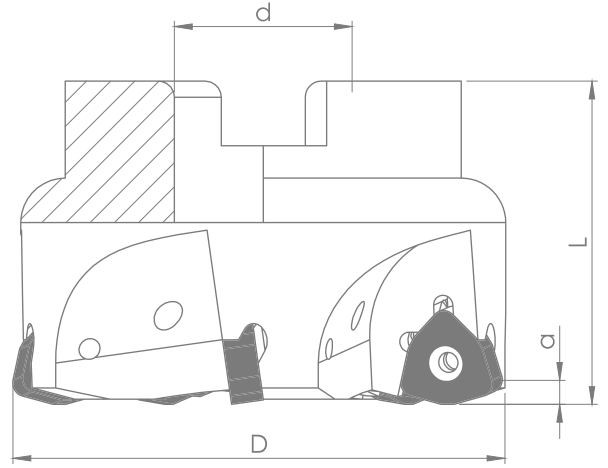

TEKNİK ÇİZİM / TECHNICAL DRAWING

TAKIM KODU ORDERING CODE	ÜRÜN KODU PRODUCT CODE	KATER ÖLÇÜLERİ DIMENSIONS (mm)				KESİCİ UÇ INSERT	TL FİYAT TL PRICE
VRFWN		D	d	L	A	KESİCİ UÇ ADET INSERT QTY	
VRFWN-09-D050-d22-Z04	VRT2529	50	22	45	5	4	₺1.836
VRFWN-09-D052-d22-Z05	VRT2530	52	22	40	5	5	₺1.944
VRFWN-09-D063-d22-Z05	VRT2531	63	22	45	5	5	₺2.232
VRFWN-09-D066-d22-Z05	VRT2532	66	22	40	5	5	₺2.331
VRFWN-09-D080-d27-Z06	VRT2533	80	27	52	5	6	₺2.665
VRFWN-09-D100-d32-Z07	VRT2534	100	32	60	5	7	₺3.099
VRFWN-13-D050-d22-Z04	VRT2535	50	22	45	6	4	₺1.836
VRFWN-13-D063-d22-Z05	VRT2536	63	22	45	6	5	₺2.232
VRFWN-13-D080-d27-Z06	VRT2537	80	27	52	6	6	₺2.665
VRFWN-13-D100-d32-Z07	VRT2538	100	32	60	6	7	₺3.099

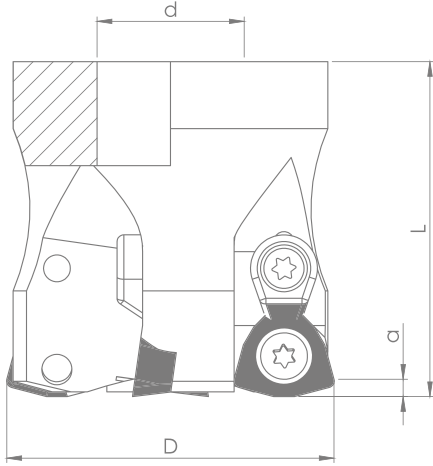

TEKNİK ÇİZİM / TECHNICAL DRAWING

**TAKIM KODU**  
ORDERING CODE

**ÜRÜN KODU**  
PRODUCT CODE

**KATER ÖLÇÜLERİ**  
DIMENSIONS (mm)

**KESİCİ UÇ**  
INSERT

**TL FİYAT**  
TL PRICE

**VRFWD**

		D	d	L	A	KESİCİ UÇ ADET INSERT QTY
VRFWD-13-D050-d22-Z04	VRT2539	50	22	40	5	4
VRFWD-13-D063-d22-Z05	VRT2540	63	22	40	5	5
VRFWD-13-D080-d27-Z06	VRT2541	80	27	50	5	6
VRFWD-13-D100-d32-Z07	VRT2542	100	32	65	5	7



**WDKT  
1305**

₺2.041

₺2.430

₺2.744

₺3.312

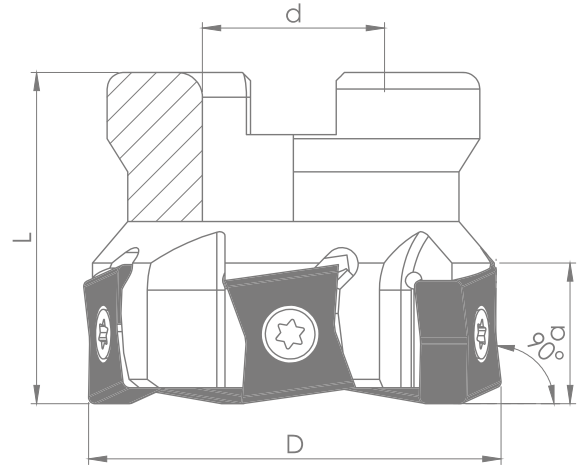

TEKNİK ÇİZİM / TECHNICAL DRAWING

**TAKIM KODU**  
ORDERING CODE

**ÜRÜN KODU**  
PRODUCT CODE

**KATER ÖLÇÜLERİ**  
DIMENSIONS (mm)

**KESİCİ UÇ**  
INSERT

**TL FİYAT**  
TL PRICE

**VRF90LN** 90°

		D	d	L	A	KESİCİ UÇ ADET INSERT QTY	
VRF90LNR/L-15-D050-d22-Z04	VRT2543	50	22	40	5	4	
VRF90LNR/L-15-D063-d22-Z05	VRT2544	63	22	40	5	5	
VRF90LNR/L-15-D080-d27-Z06	VRT2545	80	27	50	5	6	
VRF90LNR/L-15-D100-d32-Z08	VRT2546	100	32	60	5	8	
VRF90LNR/L-15-D125-d40-Z09	VRT2547	125	40	65	5	9	
VRF90LNR/L-15-D160-d40-Z10	VRT2548	160	40	65	5	10	

KESİCİ UÇ ADET  
INSERT QTY
**LN..**  
**1506**

₺2.744

₺3.043

₺3.505

₺4.203

₺4.596

₺5.205

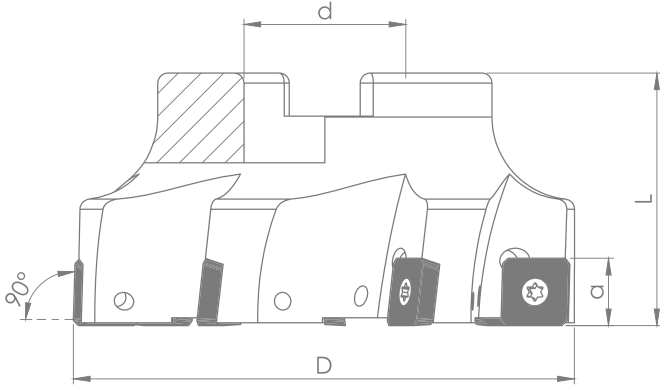

TEKNİK ÇİZİM / TECHNICAL DRAWING

TAKIM KODU ORDERING CODE	ÜRÜN KODU PRODUCT CODE	KATER ÖLÇÜLERİ DIMENSIONS (mm)	KESİCİ UÇ INSERT	TL FİYAT TL PRICE
-----------------------------	---------------------------	-----------------------------------	---------------------	----------------------

**VRF90 SE1203** 90°

D	d	L	A	KESİCİ UÇ ADET INSERT QTY
---	---	---	---	------------------------------

VRF90-SE1203-D050-d22-Z04	VRT2549	50	22	40	8	4
VRF90-SE1203-D063-d22-Z05	VRT2550	63	22	40	8	5
VRF90-SE1203-D080-d27-Z06	VRT2551	80	27	50	8	6
VRF90-SE1203-D100-d32-Z07	VRT2552	100	32	65	8	7



**SEET  
12 03**

₺2.046

₺2.430

₺2.744

₺3.312



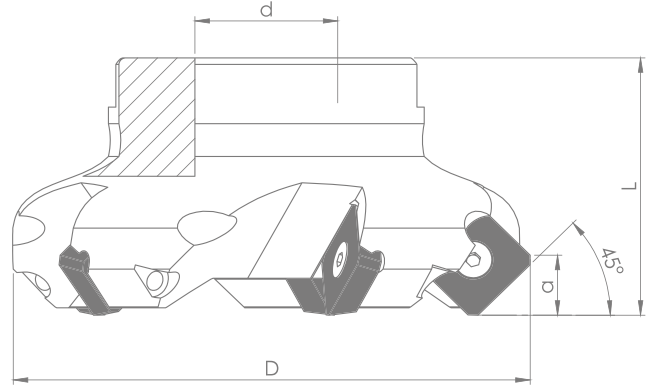

TEKNİK ÇİZİM / TECHNICAL DRAWING

TAKIM KODU ORDERING CODE	ÜRÜN KODU PRODUCT CODE	KATER ÖLÇÜLERİ DIMENSIONS (mm)				KESİCİ UÇ INSERT	TL FİYAT TL PRICE
<b>VRF45 SE12T3</b>	<b>45°</b>	<b>D</b>	<b>d</b>	<b>L</b>	<b>A</b>	<b>KESİCİ UÇ ADET INSERT QTY</b>	
VRF45-SE12T3-D050-d22-Z04	VRT2553	50	22	40	6	<b>4</b>	₺1.391
VRF45-SE12T3-D063-d22-Z05	VRT2554	63	22	40	6	<b>5</b>	₺1.769
VRF45-SE12T3-D080-d27-Z06	VRT2555	80	27	50	6	<b>6</b>	₺2.079
VRF45-SE12T3-D100-d32-Z07	VRT2556	100	32	50	6	<b>7</b>	₺2.469
VRF45-SE12T3-D125-d40-Z08	VRT2557	125	40	62	6	<b>8</b>	₺3.091
VRF45-SE12T3-D160-d40-Z10	VRT2558	160	40	62	6	<b>10</b>	₺4.820

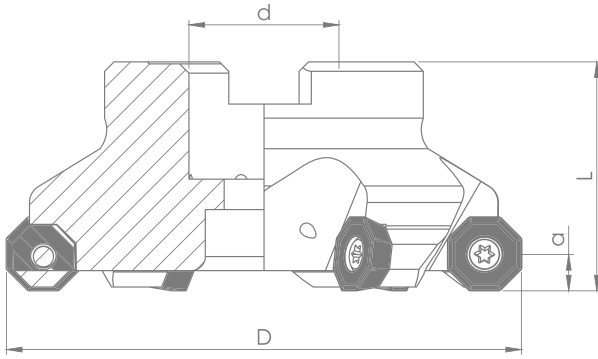

TEKNİK ÇİZİM / TECHNICAL DRAWING

TAKIM KODU ORDERING CODE	ÜRÜN KODU PRODUCT CODE	KATER ÖLÇÜLERİ DIMENSIONS (mm)	KESİCİ UÇ INSERT	TL FİYAT TL PRICE
-----------------------------	---------------------------	-----------------------------------	---------------------	----------------------

**VRF45 OD06**

45°

D	d	L	A	KESİCİ UÇ ADET INSERT QTY
---	---	---	---	------------------------------

VRF45-OD06-D050-d22-Z04	VRT2559	50	22	40	4	4
VRF45-OD06-D063-d22-Z05	VRT2560	63	22	40	4	5
VRF45-OD06-D080-d27-Z06	VRT2561	80	27	50	4	6
VRF45-OD06-D100-d32-Z07	VRT2562	100	32	50	4	7
VRF45-OD06-D125-d40-Z08	VRT2563	125	40	60	4	8
VRF45-OD06-D160-d40-Z09	VRT2564	160	40	60	4	9
VRF45-OD06-D200-d60-Z12	VRT2565	200	60	60	4	12



OD..  
06 05

₺1.609

₺2.232

₺2.430

₺2.941

₺3.572

₺4.433

₺8.311

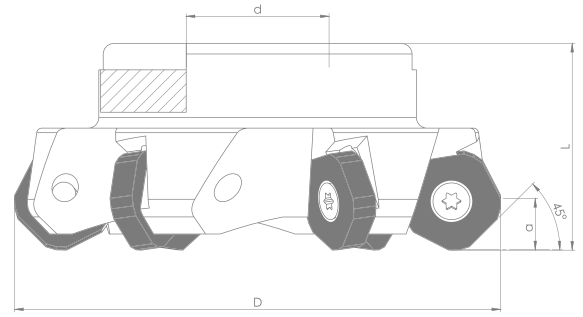

TEKNİK ÇİZİM / TECHNICAL DRAWING

**TAKIM KODU**  
ORDERING CODE

**ÜRÜN KODU**  
PRODUCT CODE

**KATER ÖLÇÜLERİ**  
DIMENSIONS (mm)

**KESİCİ UÇ**  
INSERT

**TL FİYAT**  
TL PRICE

**VRF45 PN12**    45°

D	d	L	A	KESİCİ UÇ ADET INSERT QTY
63	22	40	4	5
80	27	50	4	6
100	32	50	4	7

**PN..**  
**12 05**
**₺2.012**
**₺2.430**
**₺3.032**

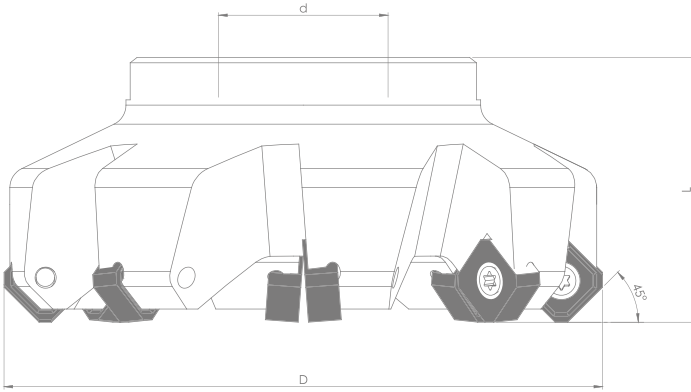

TEKNİK ÇİZİM / TECHNICAL DRAWING



**TAKIM KODU**  
ORDERING CODE

**ÜRÜN KODU**  
PRODUCT CODE

**KATER ÖLÇÜLERİ**  
DIMENSIONS (mm)

**KESİCİ UÇ**  
INSERT

**TL FİYAT**  
TL PRICE

**VRF45 SN 1205**

45°

D	d	L	A	KESİCİ UÇ ADET INSERT QTY
---	---	---	---	------------------------------

VRF45-SN1205-D050-d22-Z05	VRT2569	50	22	40	6	5
VRF45-SN1205-D063-d22-Z06	VRT2570	63	22	40	6	6
VRF45-SN1205-D080-d27-Z07	VRT2572	80	27	50	6	7
VRF45-SN1205-D100-d32-Z08	VRT2573	100	32	50	6	8
VRF45-SN1205-D125-d40-Z10	VRT2574	125	40	62	6	10
VRF45-SN1205-D160-d40-Z12	VRT2575	160	40	62	6	12



**SNMX  
1205**

₺1.790

₺2.226

₺2.525

₺2.821

₺4.742

₺5.525

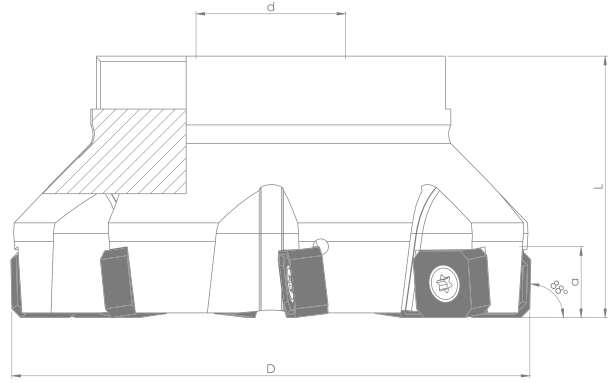

TEKNİK ÇİZİM / TECHNICAL DRAWING

**TAKIM KODU**  
ORDERING CODE

**ÜRÜN KODU**  
PRODUCT CODE

**KATER ÖLÇÜLERİ**  
DIMENSIONS (mm)

**KESİCİ UÇ**  
INSERT

**TL FİYAT**  
TL PRICE

**VRF88 SN 1205**

88°

D	d	L	A
---	---	---	---

KESİCİ UÇ ADET  
INSERT QTY
**SNMX**  
**1205**

VRF88-SN1205-D050-d22-Z05	VRT2576	50	22	40	6	5	₺1.790
VRF88-SN1205-D063-d22-Z06	VRT2577	63	22	40	6	6	₺2.226
VRF88-SN1205-D080-d27-Z07	VRT2578	80	27	50	6	7	₺2.525
VRF88-SN1205-D080-d27-Z09	VRT2579	80	27	50	6	9	₺2.821
VRF88-SN1205-D100-d32-Z08	VRT2580	100	32	50	6	8	₺3.159
VRF88-SN1205-D125-d40-Z10	VRT2581	125	40	62	6	10	₺4.742

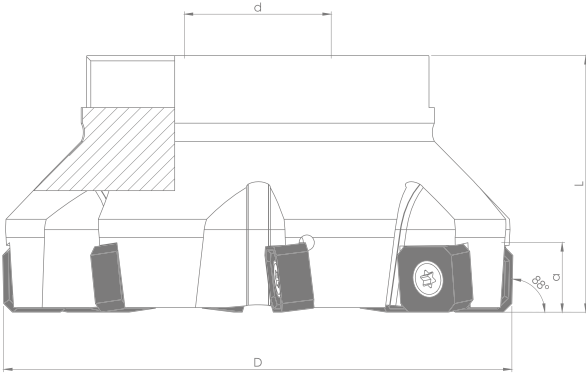

TEKNİK ÇİZİM / TECHNICAL DRAWING



**TAKIM KODU**  
ORDERING CODE

**ÜRÜN KODU**  
PRODUCT CODE

**KATER ÖLÇÜLERİ**  
DIMENSIONS (mm)

**KESİCİ UÇ**  
INSERT

**TL FİYAT**  
TL PRICE

**VRF88 SN 1206**

88°

D	d	L	A	KESİCİ UÇ ADET INSERT QTY
---	---	---	---	------------------------------

VRF88-SN1206-D050-d22-Z05	VRT2582	50	22	40	6	5
VRF88-SN1206-D063-d22-Z06	VRT2583	63	22	40	6	6
VRF88-SN1206-D080-d27-Z07	VRT2584	80	27	50	6	7
VRF88-SN1206-D100-d32-Z08	VRT2585	100	32	50	6	8
VRF88-SN1206-D125-d40-Z10	VRT2586	125	40	62	6	10
VRF88-SN1206-D160-d40-Z12	VRT2587	160	40	62	6	12



**SNMX  
1206**

₺1.790

₺2.226

₺2.525

₺2.821

₺4.742

₺5.525

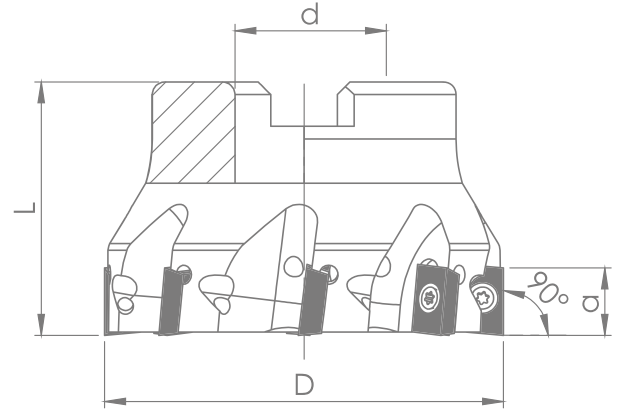

TEKNİK ÇİZİM / TECHNICAL DRAWING

**TAKIM KODU**  
ORDERING CODE

**ÜRÜN KODU**  
PRODUCT CODE

**KATER ÖLÇÜLERİ**  
DIMENSIONS (mm)

**KESİCİ UÇ**  
INSERT

**TL FİYAT**  
TL PRICE
**VRF90 AP1135****88°**

D	d	L	A
---	---	---	---

KESİCİ UÇ ADET  
INSERT QTY

VRF90-AP1135-D040-d16-Z06 VRT2588

40 16 40 9

6

₺1.767

VRF90-AP1135-D050-d22-Z07 VRT2589

50 22 40 9

7

**AP..  
1135**

₺2.102

VRF90-AP1135-D063-d22-Z08 VRT2590

63 22 40 9

8

₺2.298

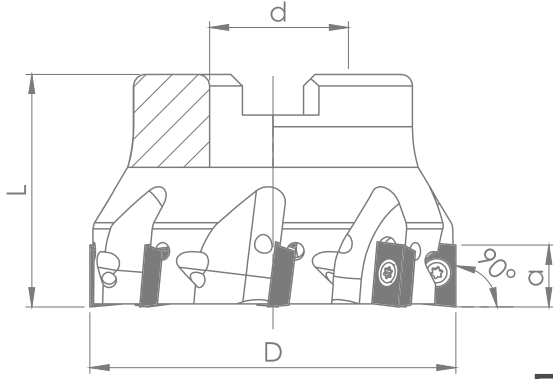

TEKNİK ÇİZİM / TECHNICAL DRAWING

 TAKIM KODU  
ORDERING CODE

 ÜRÜN KODU  
PRODUCT CODE

 KATER ÖLÇÜLERİ  
DIMENSIONS (mm)

 KESİCİ UÇ  
INSERT

 TL FİYAT  
TL PRICE

**VRF90 AP11 R390 90°**

		D	d	L	A	KESİCİ UÇ ADET INSERT QTY		
VRF90-AP11R390-D040-d16-Z05	VRT2591	40	16	40	9	5		₺1.235
VRF90-AP11R390-D050-d22-Z06	VRT2592	50	22	40	9	6	AP.. 11 R390	₺1.543
VRF90-AP11R390-D063-d22-Z07	VRT2593	63	22	40	9	7		₺1.807
VRF90-AP11R390-D080-d27-Z08	VRT2594	80	27	50	9	8		₺2.298
VRF90-AP17R390-D040-d16-Z04	VRT2595	40	16	40	14	4	AP.. 17 R390	₺1.235
VRF90-AP17R390-D050-d22-Z05	VRT2596	50	22	40	14	5		₺1.543
VRF90-AP17R390-D063-d22-Z06	VRT2597	63	22	40	14	6		₺1.807
VRF90-AP17R390-D080-d27-Z07	VRT2598	80	27	50	14	7		₺2.298
VRF90-AP17R390-D100-d32-Z08	VRT2599	100	32	50	14	8		₺2.457
VRF90-AP17R390-D125-d40-Z09	VRT2600	125	40	60	14	9	₺3.761	
VRF90-AP18R390-D040-d16-Z03	VRT2601	40	16	40	15	3	AP.. 18 R390	₺1.589
VRF90-AP18R390-D050-d22-Z04	VRT2602	50	22	40	15	4		₺1.750
VRF90-AP18R390-D063-d22-Z05	VRT2603	63	22	40	15	5		₺2.113
VRF90-AP18R390-D080-d27-Z06	VRT2604	80	27	50	15	6		₺2.486
VRF90-AP18R390-D100-d32-Z07	VRT2605	100	32	60	15	7		₺2.755
VRF90-AP18R390-D125-d40-Z08	VRT2606	125	40	60	15	8		₺3.761



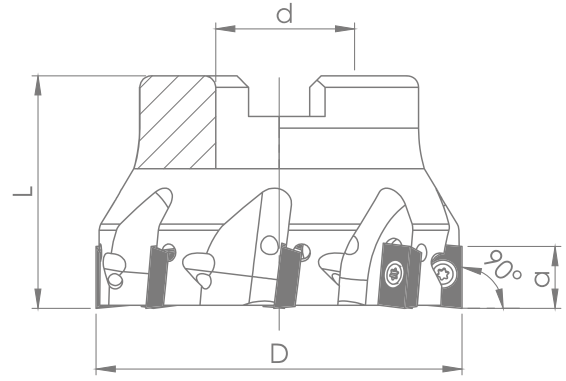

TEKNİK ÇİZİM / TECHNICAL DRAWING

**TAKIM KODU**  
ORDERING CODE

**ÜRÜN KODU**  
PRODUCT CODE

**KATER ÖLÇÜLERİ**  
DIMENSIONS (mm)

**KESİCİ UÇ**  
INSERT

**TL FİYAT**  
TL PRICE

**VRF90 AX17** 90°

VRF90-AX17-D040-d16-Z04 VRT2607

VRF90-AX17-D050-d22-Z05 VRT2608

VRF90-AX17-D063-d22-Z06 VRT2609

VRF90-AX17-D080-d27-Z07 VRT2610

D	d	L	A
---	---	---	---

40 16 40 15

50 22 40 15

63 22 40 15

80 27 50 15

**KESİCİ UÇ ADET**  
INSERT QTY

4

5

6

7

**AX..**  
**1705**

₺1.235

₺1.807

₺2.298

₺2.457

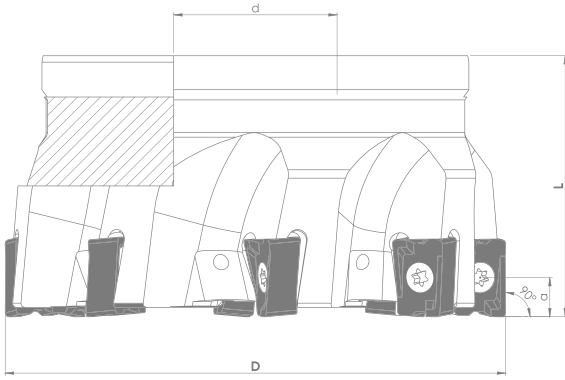

TEKNİK ÇİZİM / TECHNICAL DRAWING



TAKIM KODU ORDERING CODE	ÜRÜN KODU PRODUCT CODE	KATER ÖLÇÜLERİ DIMENSIONS (mm)	KESİCİ UÇ INSERT	TL FİYAT TL PRICE
-----------------------------	---------------------------	-----------------------------------	---------------------	----------------------

**VRF90 LN13 90°**

		D	d	L	A	KESİCİ UÇ ADET INSERT QTY
VRF90-LN13-D063-d22-Z06	VRT2611	63	22	40	12	6
VRF90-LN13-D080-d27-Z07	VRT2612	80	27	50	12	7
VRF90-LN13-D100-d32-Z08	VRT2613	100	32	50	12	8
VRF90-LN13-D125-d40-Z10	VRT2614	125	40	60	12	10



LN..  
1307

₺1.820

₺2.311

₺3.042

₺3.818

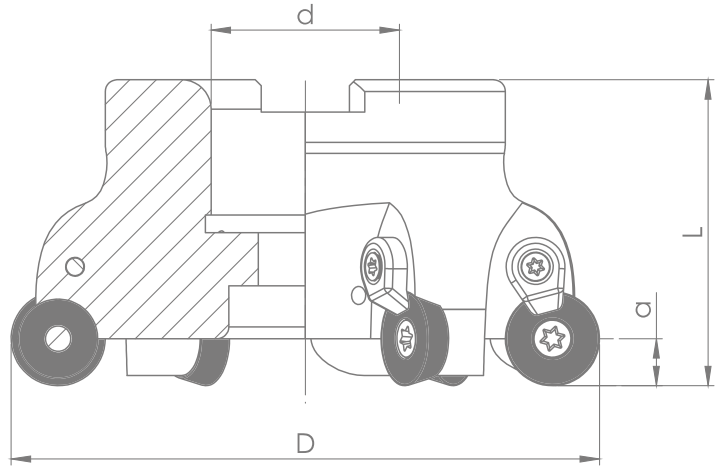

TEKNİK ÇİZİM / TECHNICAL DRAWING

TAKIM KODU ORDERING CODE	ÜRÜN KODU PRODUCT CODE	KATER ÖLÇÜLERİ DIMENSIONS (mm)				KESİCİ UÇ INSERT	TL FİYAT TL PRICE
D	d	L	A	KESİCİ UÇ ADET INSERT QTY			
VRF-RP10-D040-d16-Z04	VRT2616	40	16	40	5	4	₺1.296
VRF-RP10-D050-d22-Z05	VRT2617	50	22	40	5	5	₺1.578
VRF-RP10-D063-d22-Z06	VRT2618	63	22	40	5	6	₺2.067
VRF-RP10-D080-d27-Z07	VRT2619	80	27	50	5	7	₺2.412
VRF-RP10-D100-d32-Z08	VRT2620	100	32	50	5	8	₺2.674
VRF-RP12-D040-d16-Z04	VRT2621	40	16	40	5	4	₺1.346
VRF-RP12-D050-d22-Z05	VRT2622	50	22	40	5	5	₺1.578
VRF-RP12-D063-d22-Z06	VRT2623	63	22	40	5	6	₺2.067
VRF-RP12-D080-d27-Z07	VRT2624	80	27	50	5	7	₺2.412
VRF-RP12-D100-d32-Z08	VRT2625	100	32	50	5	8	₺2.674

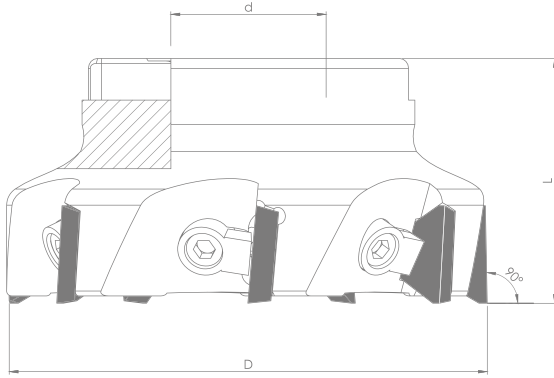

TEKNİK ÇİZİM / TECHNICAL DRAWING



TAKIM KODU ORDERING CODE	ÜRÜN KODU PRODUCT CODE	KATER ÖLÇÜLERİ DIMENSIONS (mm)	KESİCİ UÇ INSERT	TL FİYAT TL PRICE
-----------------------------	---------------------------	-----------------------------------	---------------------	----------------------

VRF90C TP22 90°		D	d	L	A	KESİCİ UÇ ADET INSERT QTY
VRF90C-TP22-D063-d22-Z05	VRT2626	63	22	40	18	5
VRF90C-TP22-D080-d27-Z06	VRT2627	80	27	50	18	6
VRF90C-TP22-D100-d32-Z07	VRT2628	100	32	50	18	7
VRF90C-TP22-D125-d40-Z08	VRT2629	125	40	62	18	8
VRF90C-TP22-D160-d40-Z09	VRT2630	160	40	62	18	9



TP..  
22 04

	₺2.430
	₺2.665
	₺3.644
	₺4.861
	₺5.537

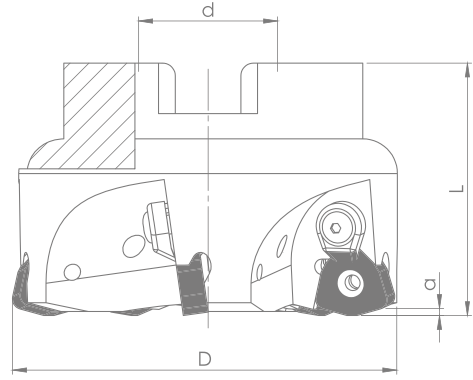

TEKNİK ÇİZİM / TECHNICAL DRAWING

**TAKIM KODU**  
ORDERING CODE

**ÜRÜN KODU**  
PRODUCT CODE

**KATER ÖLÇÜLERİ**  
DIMENSIONS (mm)

**KESİCİ UÇ**  
INSERT

**TL FİYAT**  
TL PRICE

## VRFJD 1204

	D	d	L	A	KESİCİ UÇ ADET INSERT QTY		
VRFJD-JD1204-D050-d22-Z04 VRT2631	50	22	40	2	4		₺1.516
VRFJD-JD1204-D063-d22-Z05 VRT2632	63	22	40	2	5		₺1.815
VRFJD-JD1204-D080-d27-Z06 VRT2633	80	27	50	2	6	<b>JD.. 12 04</b>	₺2.113

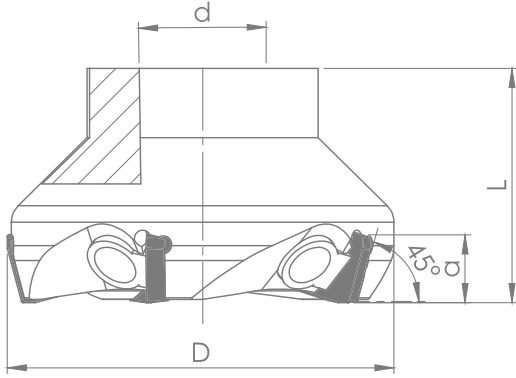

TEKNİK ÇİZİM / TECHNICAL DRAWING



TAKIM KODU  
ORDERING CODE

ÜRÜN KODU  
PRODUCT CODE

KATER ÖLÇÜLERİ  
DIMENSIONS (mm)

KESİCİ UÇ  
INSERT

TL FİYAT  
TL PRICE

**VRF45 SEKN12 45°**

D	d	L	A
---	---	---	---

KESİCİ UÇ ADET  
INSERT QTY

VRF45-SEK12-D050-d22-Z04	VRT2634	50	22	40	5	4
VRF45-SEK12-D063-d22-Z05	VRT2635	63	22	40	5	5
VRF45-SEK12-D080-d27-Z06	VRT2636	80	27	50	5	6
VRF45-SEK12-D100-d32-Z08	VRT2637	100	32	50	5	8



**SEKN  
1203**

₺1.555

₺1.724

₺2.079

₺2.525

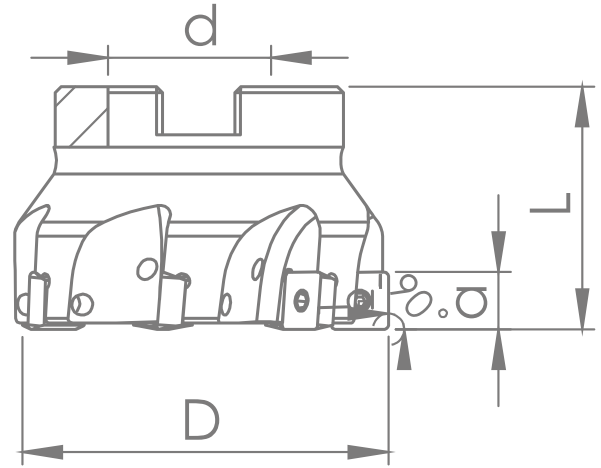

TEKNİK ÇİZİM / TECHNICAL DRAWING

TAKIM KODU ORDERING CODE	ÜRÜN KODU PRODUCT CODE	KATER ÖLÇÜLERİ DIMENSIONS (mm)				KESİCİ UÇ INSERT	TL FİYAT TL PRICE
<b>VRF SD 90°</b>		<b>D</b>	<b>d</b>	<b>L</b>	<b>A</b>	<b>KESİCİ UÇ ADET INSERT QTY</b>	
VRF90-SD09T3-D040-d16-Z05	VRT2638	40	16	40	9	5	₺2.224
VRF90-SD09T3-D050-d22-Z06	VRT2639	50	22	40	9	6	₺2.510
VRF90-SD09T3-D063-d22-Z07	VRT2640	63	22	40	9	7	₺2.805
VRF90-SD09T3-D080-d27-Z08	VRT2641	80	27	50	9	8	₺3.210
VRF90-SD1204-D080-d27-Z06	VRT2642	80	27	50	12	6	₺3.210
VRF90-SD1204-D100-d32-Z07	VRT2643	100	32	50	12	7	₺3.845





[www.vorgen.com](http://www.vorgen.com)

**VORGEN®**

# PARMAK FREZE TAKIMLARI

END MILLING  
TOOL HOLDERS

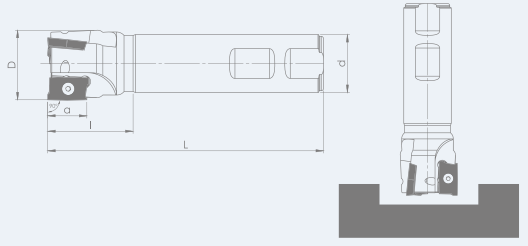

TEKNİK ÇİZİM / TECHNICAL DRAWING

TAKIM KODU ORDERING CODE	ÜRÜN KODU PRODUCT CODE	KATER ÖLÇÜLERİ DIMENSIONS (mm)	KESİCİ UÇ INSERT	TL FİYAT TL PRICE
-----------------------------	---------------------------	-----------------------------------	---------------------	----------------------

**SPAP 16 90°**

		D	d	L	KESİCİ UÇ ADET INSERT QTY		
SPAP16 - S02 D25 d25 L100	VRT2644	25	25	100	2		₺924
SPAP16 - S02 D30 d25 L100	VRT2645	30	25	100	2		₺972
SPAP16 - S03 D32 d25 L100	VRT2646	32	25	100	3		₺1.037
SPAP16 - S03 D35 d25 L100	VRT2647	35	25	100	3		₺1.049
SPAP16 - S03 D40 d32 L100	VRT2648	40	32	100	3		₺1.226
SPAP16 - S04 D45 d32 L100	VRT2649	45	32	100	4		₺1.391
SPAP16 - S04 D50 d32 L100	VRT2650	50	32	100	4		₺1.489
SPAP16 - S02 D25 d25 L120	VRT2651	25	25	120	2		₺1.001
SPAP16 - S02 D30 d25 L120	VRT2652	30	25	120	2		₺1.026
SPAP16 - S03 D32 d25 L120	VRT2653	32	25	120	3		₺1.049
SPAP16 - S03 D35 d25 L120	VRT2654	35	25	120	3		₺1.156
SPAP16 - S03 D40 d32 L120	VRT2655	40	32	120	3		₺1.226
SPAP16 - S04 D45 d32 L120	VRT2656	45	32	120	4		₺1.396
SPAP16 - S05 D50 d32 L120	VRT2657	50	32	120	5		₺1.433
SPAP16 - S02 D25 d25 L150	VRT2658	25	25	150	2	<b>APKT 1604</b>	₺1.344
SPAP16 - S02 D30 d25 L150	VRT2659	30	25	150	2		₺1.396
SPAP16 - S03 D32 d25 L150	VRT2660	32	25	150	3		₺1.421
SPAP16 - S03 D35 d25 L150	VRT2661	35	25	150	3		₺1.443
SPAP16 - S03 D40 d32 L150	VRT2662	40	32	150	3		₺1.508
SPAP16 - S04 D45 d32 L150	VRT2663	45	32	150	4		₺1.690
SPAP16 - S05 D50 d32 L150	VRT2664	50	32	150	5		₺1.768
SPAP16 - S02 D25 d25 L200	VRT2665	25	25	200	2		₺1.504
SPAP16 - S02 D30 d25 L200	VRT2666	30	25	200	2		₺1.515
SPAP16 - S03 D32 d25 L200	VRT2667	32	25	200	3		₺1.621
SPAP16 - S03 D35 d25 L200	VRT2668	35	25	200	3	₺1.669	
SPAP16 - S03 D40 d32 L200	VRT2669	40	32	200	3	₺1.842	
SPAP16 - S04 D45 d32 L200	VRT2670	45	32	200	4	₺1.967	
SPAP16 - S05 D50 d32 L200	VRT2671	50	32	200	5	₺2.037	

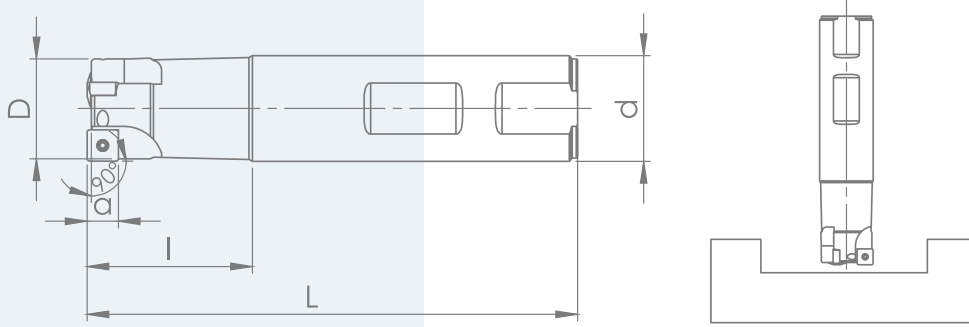

TEKNİK ÇİZİM / TECHNICAL DRAWING

TAKIM KODU ORDERING CODE	ÜRÜN KODU PRODUCT CODE	KATER ÖLÇÜLERİ DIMENSIONS (mm)	KESİCİ UÇ INSERT	TL FİYAT TL PRICE
-----------------------------	---------------------------	-----------------------------------	---------------------	----------------------

**SPSD 09** 90°

		D	d	L	KESİCİ UÇ ADET INSERT QTY		
SPSD 09 - S02 D20 d20 L150	VRT2868	20	20	150	2		₺2.258
SPSD 09 - S02 D25 d25 L150	VRT2869	25	25	150	2	<b>SD..09T3</b>	₺2.370
SPSD 09 - S02 D28 d25 L150	VRT2870	28	25	150	2		₺2.430
SPSD 09 - S03 D32 d25 L150	VRT2871	32	25	150	3		₺2.535

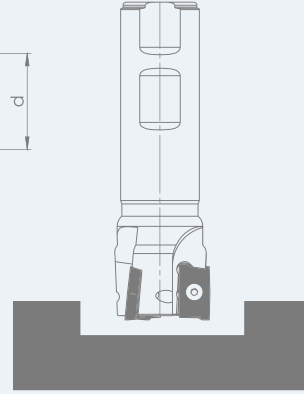
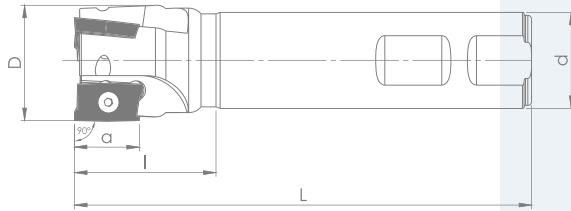



TEKNİK ÇİZİM / TECHNICAL DRAWING

TAKIM KODU ORDERING CODE	ÜRÜN KODU PRODUCT CODE	KATER ÖLÇÜLERİ DIMENSIONS (mm)	KESİCİ UÇ INSERT	TL FİYAT TL PRICE
-----------------------------	---------------------------	-----------------------------------	---------------------	----------------------

**SPAP 10 90°**

		D	d	L	KESİCİ UÇ ADET INSERT QTY		
SPAP10 - S01 D10 d10 L100	VRT2672	10	10	100	1		₺715
SPAP10 - S01 D12 d12 L100	VRT2673	12	12	100	1		₺715
SPAP10 - S01 D14 d14 L100	VRT2674	14	14	100	1		₺715
SPAP10 - S02 D16 d16 L100	VRT2675	16	16	100	2		₺926
SPAP10 - S02 D18 d16 L100	VRT2676	18	16	100	2		₺926
SPAP10 - S03 D20 d20 L100	VRT2677	20	20	100	3		₺1.037
SPAP10 - S03 D22 d20 L100	VRT2678	22	20	100	3		₺1.037
SPAP10 - S03 D25 d25 L100	VRT2679	25	25	100	3	APKT 1003	₺1.082
SPAP10 - S03 D28 d25 L100	VRT2680	28	25	100	3		₺1.082
SPAP10 - S04 D30 d25 L100	VRT2681	30	25	100	4		₺1.249
SPAP10 - S04 D32 d25 L100	VRT2682	32	25	100	4		₺1.381
SPAP10 - S04 D35 d25 L100	VRT2683	35	25	100	4		₺1.381

TAKIM KODU ORDERING CODE	ÜRÜN KODU PRODUCT CODE	KATER ÖLÇÜLERİ DIMENSIONS (mm)	KESİCİ UÇ INSERT	TL FİYAT TL PRICE
-----------------------------	---------------------------	-----------------------------------	---------------------	----------------------

SPAP 10	90°	KATER ÖLÇÜLERİ DIMENSIONS (mm)			KESİCİ UÇ ADET INSERT QTY	KESİCİ UÇ INSERT	TL FİYAT TL PRICE
		D	d	L			
SPAP10 - S01 D10 d10 L120	VRT2684	10	10	120	1		₺818
SPAP10 - S01 D12 d12 L120	VRT2685	12	12	120	1		₺818
SPAP10 - S01 D14 d14 L120	VRT2686	14	14	120	1		₺818
SPAP10 - S02 D16 d16 L120	VRT2687	16	16	120	2		₺1.035
SPAP10 - S02 D18 d16 L120	VRT2688	18	16	120	2		₺1.035
SPAP10 - S03 D20 d20 L120	VRT2689	20	20	120	3		₺1.114
SPAP10 - S03 D22 d20 L120	VRT2690	22	20	120	3		₺1.114
SPAP10 - S03 D25 d25 L120	VRT2691	25	25	120	3		₺1.183
SPAP10 - S03 D28 d25 L120	VRT2692	28	25	120	3		₺1.183
SPAP10 - S04 D30 d25 L120	VRT2693	30	25	120	4		₺1.300
SPAP10 - S04 D32 d25 L120	VRT2694	32	25	120	4		₺1.391
SPAP10 - S04 D35 d25 L120	VRT2695	35	25	120	4		₺1.391
SPAP10 - S05 D40 d32 L120	VRT2696	40	32	120	5		₺1.466
SPAP10 - S01 D10 d10 L150	VRT2697	10	10	150	1		₺1.009
SPAP10 - S01 D12 d12 L150	VRT2698	12	12	150	1		₺1.009
SPAP10 - S01 D14 d14 L150	VRT2699	14	14	150	1		₺1.009
SPAP10 - S02 D16 d16 L150	VRT2700	16	16	150	2		₺1.114
SPAP10 - S02 D18 d16 L150	VRT2701	18	16	150	2		₺1.114
SPAP10 - S03 D20 d20 L150	VRT2702	20	20	150	3		₺1.348
SPAP10 - S03 D22 d20 L150	VRT2703	22	20	150	3		₺1.348
SPAP10 - S03 D25 d25 L150	VRT2704	25	25	150	3	APKT 1003	₺1.381
SPAP10 - S03 D28 d25 L150	VRT2705	28	25	150	3		₺1.381
SPAP10 - S04 D30 d25 L150	VRT2706	30	25	150	4		₺1.559
SPAP10 - S04 D32 d25 L150	VRT2707	32	25	150	4		₺1.581
SPAP10 - S04 D35 d25 L150	VRT2708	35	25	150	4		₺1.581
SPAP10 - S05 D40 d32 L150	VRT2709	40	32	150	5		₺1.668
SPAP10 - S02 D16 d16 L200	VRT2710	16	16	200	2		₺1.300
SPAP10 - S02 D18 d16 L200	VRT2711	18	16	200	2		₺1.300
SPAP10 - S03 D20 d20 L200	VRT2712	20	20	200	3		₺1.516
SPAP10 - S03 D22 d20 L200	VRT2713	22	20	200	3		₺1.516
SPAP10 - S03 D25 d25 L200	VRT2714	25	25	200	3		₺1.559
SPAP10 - S03 D28 d25 L200	VRT2715	28	25	200	3		₺1.559
SPAP10 - S04 D30 d25 L200	VRT2716	30	25	200	4		₺1.742
SPAP10 - S04 D32 d25 L200	VRT2717	32	25	200	4		₺1.758
SPAP10 - S04 D35 d25 L200	VRT2718	35	25	200	4		₺1.758
SPAP10 - S05 D40 d32 L200	VRT2719	40	32	200	5		₺1.855
SPAP10 - S02 D16 d16 L250	VRT2720	16	16	250	2		₺1.911
SPAP10 - S02 D18 d16 L250	VRT2721	18	16	250	2		₺1.923
SPAP10 - S03 D20 d20 L250	VRT2722	20	20	250	3		₺2.152
SPAP10 - S03 D25 d25 L250	VRT2723	25	25	250	3		₺2.201

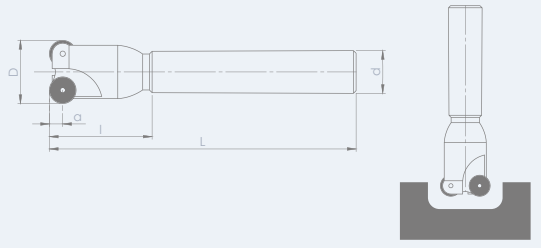

TEKNİK ÇİZİM / TECHNICAL DRAWING

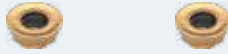

TAKIM KODU ORDERING CODE	ÜRÜN KODU PRODUCT CODE	KATER ÖLÇÜLERİ DIMENSIONS (mm)	KESİCİ UÇ INSERT	TL FİYAT TL PRICE
-----------------------------	---------------------------	-----------------------------------	---------------------	----------------------

**SPRD**

		D	d	L	KESİCİ UÇ ADET INSERT QTY		
SPRD1204 - S02 D25 d25 L120	VRT2724	25	25	120	2		₺1.114
SPRD1204 - S02 D28 d25 L120	VRT2725	28	25	120	2		₺1.114
SPRD1204 - S02 D30 d25 L120	VRT2726	30	25	120	2		₺1.170
SPRD1204 - S03 D32 d25 L120	VRT2727	32	25	120	3		₺1.187
SPRD1204 - S03 D35 d32 L120	VRT2728	35	32	120	3		₺1.187
SPRD1204 - S03 D40 d32 L120	VRT2729	40	32	120	3		₺1.296
SPRD1204 - S02 D25 d25 L150	VRT2730	25	25	150	2		₺1.217
SPRD1204 - S02 D28 d25 L150	VRT2731	28	25	150	2		₺1.217
SPRD1204 - S02 D30 d25 L150	VRT2732	30	25	150	2		₺1.279
SPRD1204 - S03 D32 d25 L150	VRT2733	32	25	150	3		₺1.296
SPRD1204 - S03 D35 d25 L150	VRT2734	35	25	150	3		₺1.296
SPRD1204 - S03 D40 d32 L150	VRT2735	40	32	150	3		₺1.401
SPRD1204 - S02 D25 d25 L200	VRT2736	25	25	200	2		₺1.443
SPRD1204 - S02 D28 d25 L200	VRT2737	28	25	200	2		₺1.443
SPRD1204 - S02 D30 d25 L200	VRT2738	30	25	200	2		₺1.508
SPRD1204 - S03 D32 d25 L200	VRT2739	32	25	200	3		₺1.508
SPRD1204 - S03 D35 d25 L200	VRT2740	35	25	200	3		₺1.737
SPRD1204 - S03 D40 d32 L200	VRT2741	40	32	200	3		₺1.788

 RD..  
1204

TAKIM KODU ORDERING CODE	ÜRÜN KODU PRODUCT CODE	KATER ÖLÇÜLERİ DIMENSIONS (mm)			KESİCİ UÇ INSERT	TL FİYAT TL PRICE
-----------------------------	---------------------------	-----------------------------------	--	--	---------------------	----------------------

SPRD 10		D	d	L	KESİCİ UÇ ADET INSERT QTY		TL FİYAT TL PRICE
							
SPRD1003 - S02 D20 d20 L120	VRT2742	20	20	120	2		₺1.087
SPRD1003 - S02 D25 d25 L120	VRT2743	25	25	120	2		₺1.114
SPRD1003 - S03 D28 d25 L120	VRT2744	28	25	120	3		₺1.114
SPRD1003 - S03 D30 d25 L120	VRT2745	30	25	120	3		₺1.170
SPRD1003 - S03 D32 d25 L120	VRT2746	32	25	120	3		₺1.195
SPRD1003 - S03 D35 d25 L120	VRT2747	35	25	120	3		₺1.195
SPRD1003 - S03 D35 d25 L120	VRT2748	35	25	120	3		₺1.195
SPRD1003 - S04 D40 d32 L120	VRT2749	40	32	120	4		₺1.296
SPRD1003 - S02 D20 d20 L150	VRT2750	20	20	150	2		₺1.183
SPRD1003 - S02 D25 d25 L150	VRT2751	25	25	150	2		₺1.217
SPRD1003 - S03 D28 d25 L150	VRT2752	28	25	150	3		₺1.217
SPRD1003 - S03 D30 d25 L150	VRT2753	30	25	150	3		₺1.279
SPRD1003 - S03 D32 d25 L150	VRT2754	32	25	150	3		₺1.279
SPRD1003 - S03 D35 d25 L150	VRT2755	35	25	150	3		₺1.279
SPRD1003 - S03 D35 d32 L150	VRT2756	35	32	150	3		₺1.279
SPRD1003 - S04 D40 d32 L150	VRT2757	40	32	150	4		₺1.396
SPRD1003 - S02 D20 d20 L200	VRT2758	20	20	200	2		₺1.516
SPRD1003 - S02 D25 d25 L200	VRT2759	25	25	200	2		₺1.559
SPRD1003 - S03 D28 d25 L200	VRT2760	28	25	200	3		₺1.559
SPRD1003 - S03 D30 d25 L200	VRT2761	30	25	200	3		₺1.621
SPRD1003 - S03 D32 d25 L200	VRT2762	32	25	200	3		₺1.621
SPRD1003 - S03 D35 d25 L200	VRT2763	35	25	200	3		₺1.621
SPRD1003 - S03 D35 d32 L200	VRT2764	35	32	200	3		₺1.621
SPRD1003 - S04 D40 d32 L200	VRT2765	40	32	200	4		₺1.842
SPRD1003 - S02 D20 d20 L250	VRT2766	20	20	250	2		₺1.855
SPRD1003 - S02 D25 d25 L250	VRT2767	25	25	250	2		₺1.899

RD..  
1003

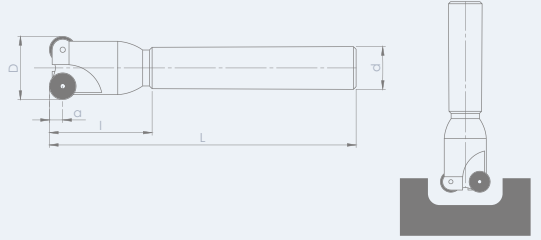

TEKNİK ÇİZİM / TECHNICAL DRAWING

TAKIM KODU ORDERING CODE	ÜRÜN KODU PRODUCT CODE	KATER ÖLÇÜLERİ DIMENSIONS (mm)			KESİCİ UÇ INSERT	TL FİYAT TL PRICE
<b>SPRP</b>		<b>D</b>	<b>d</b>	<b>L</b>	<b>KESİCİ UÇ ADET INSERT QTY</b>	
SPRP 1003 - S02 D20 d20 L120	VRT2768	20	20	120	2	₺1.087
SPRP 1003 - S02 D25 d25 L120	VRT2769	25	25	120	2	₺1.114
SPRP 1003 - S03 D30 d25 L120	VRT2770	30	25	120	3	₺1.183
SPRP 1003 - S03 D32 d25 L120	VRT2771	32	25	120	3	₺1.195
SPRP 1003 - S03 D35 d32 L120	VRT2772	35	32	120	3	₺1.195
SPRP 1003 - S02 D20 d20 L150	VRT2773	20	20	150	2	₺1.188
SPRP 1003 - S02 D25 d25 L150	VRT2774	25	25	150	2	₺1.217
SPRP 1003 - S03 D30 d25 L150	VRT2775	30	25	150	3	₺1.279
SPRP 1003 - S03 D32 d25 L150	VRT2776	32	25	150	3	₺1.279
SPRP 1003 - S03 D35 d32 L150	VRT2777	35	32	150	3	₺1.279
SPRP 1204 - S02 D25 d25 L120	VRT2778	25	25	120	2	₺1.114
SPRP 1204 - S02 D30 d25 L120	VRT2779	30	25	120	2	₺1.183
SPRP 1204 - S03 D32 d25 L120	VRT2780	32	25	120	3	₺1.279
SPRP 1204 - S03 D35 d25 L120	VRT2781	35	25	120	3	₺1.279
SPRP 1204 - S02 D25 d25 L150	VRT2782	25	25	150	2	₺1.195
SPRP 1204 - S02 D30 d25 L150	VRT2783	30	25	150	2	₺1.217
SPRP 1204 - S03 D32 d25 L150	VRT2784	32	25	150	3	₺1.279
SPRP 1204 - S03 D35 d32 L150	VRT2785	35	32	150	3	₺1.279





TEKNİK ÇİZİM / TECHNICAL DRAWING



TAKIM KODU ORDERING CODE	ÜRÜN KODU PRODUCT CODE	KATER ÖLÇÜLERİ DIMENSIONS (mm)			KESİCİ UÇ INSERT	TL FİYAT TL PRICE
<b>SPWN</b>		<b>D</b>	<b>d</b>	<b>L</b>	<b>KESİCİ UÇ ADET INSERT QTY</b>	
SPWN06 - S02 D16 d16 L150H	VRT2786	16	16	150	2	₺2.088
SPWN06 - S02 D20 d20 L150H	VRT2787	20	20	150	3	₺2.244
SPWN09 - S02 D25 d25 L150H	VRT2788	25	25	150	2	₺2.321
SPWN09 - S02 D26 d25 L150H	VRT2789	26	25	150	2	₺2.370



TEKNİK ÇİZİM / TECHNICAL DRAWING



TAKIM KODU ORDERING CODE	ÜRÜN KODU PRODUCT CODE	KATER ÖLÇÜLERİ DIMENSIONS (mm)				KESİCİ UÇ INSERT	TL FİYAT TL PRICE
<b>BTKR</b>		<b>D</b>	<b>d1</b>	<b>L</b>	<b>L1</b>		
BTKR08 - 10-110	VRT2790	8	10	110	25	Q8 WLTR	₺1.188
BTKR10 - 12-130	VRT2791	10	12	130	30	Q10 WLTR	₺1.226
BTKR12 - 12-130	VRT2792	12	12	130	32	Q12 WLTR	₺1.226
BTKR16 - 16-175	VRT2793	16	16	175	60	Q16 WLTR	₺1.443
BTKR20 - 20-200	VRT2794	20	20	200	100	Q20 WLTR	₺1.572
BTKR25 - 25-200	VRT2795	25	25	200	100	Q25 WLTR	₺1.606
BTKR32 - 32-200	VRT2796	32	32	200	100	Q32 WLTR	₺1.720

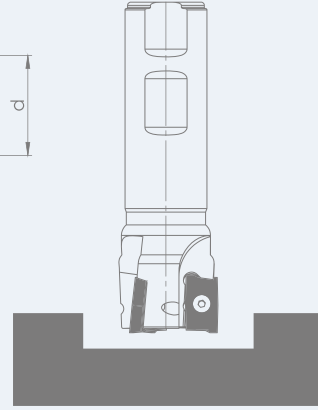
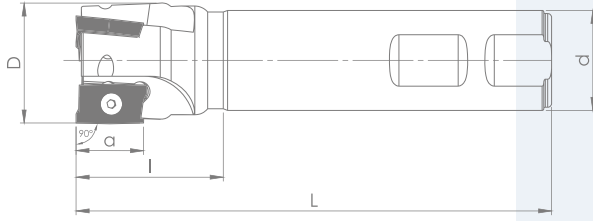

TEKNİK ÇİZİM / TECHNICAL DRAWING

TAKIM KODU ORDERING CODE	ÜRÜN KODU PRODUCT CODE	KATER ÖLÇÜLERİ DIMENSIONS (mm)			KESİCİ UÇ INSERT	TL FİYAT TL PRICE
<b>SPLN</b>	<b>90°</b>	<b>D</b>	<b>d</b>	<b>L</b>	<b>KESİCİ UÇ ADET INSERT QTY</b>	
SPLN10 - S02 D18 d16 L150	VRT2801	18	16	150	2	₺1.114
SPLN10 - S02 D20 d20 L150	VRT2802	20	20	150	2	₺1.348
SPLN10 - S02 D21 d20 L150	VRT2803	21	20	150	2	<b>LNMT 10 06</b> ₺1.348
SPLN10 - S03 D25 d25 L150	VRT2804	25	25	150	3	₺1.381
SPLN10 - S03 D26 d25 L150	VRT2805	26	25	150	3	₺1.381
SPLN15 - S02 D32 d32 L200	VRT2806	32	32	200	2	<b>LNMT 15 10</b> ₺1.758
SPLN15 - S02 D33 d32 L200	VRT2807	33	32	200	2	₺1.758

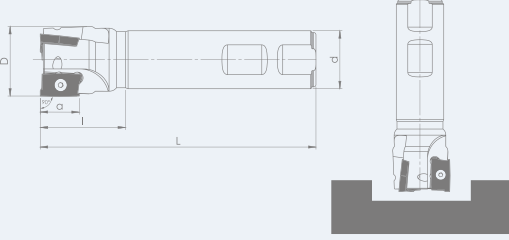

TEKNİK ÇİZİM / TECHNICAL DRAWING



TAKIM KODU ORDERING CODE	ÜRÜN KODU PRODUCT CODE	KATER ÖLÇÜLERİ DIMENSIONS (mm)			KESİCİ UÇ INSERT	TL FİYAT TL PRICE
<b>SPLO</b> 90°		<b>D</b>	<b>d</b>	<b>L</b>	KESİCİ UÇ ADET INSERT QTY	
SPLO 15 - S02 D25 d25 L150	VRT2808	25	25	150	2	₺1.526
SPLO 15 - S03 D32 d25 L150	VRT2809	32	25	150	3	₺1.581



TEKNİK ÇİZİM / TECHNICAL DRAWING



TAKIM KODU ORDERING CODE	ÜRÜN KODU PRODUCT CODE	KATER ÖLÇÜLERİ DIMENSIONS (mm)			KESİCİ UÇ INSERT	TL FİYAT TL PRICE
<b>SPXN</b>		<b>D</b>	<b>d</b>	<b>L</b>	KESİCİ UÇ ADET INSERT QTY	
SPXN 06H - S02 D21 d20 L200	VRT2810	21	20	200	2	₺2.258
SPXN 06H - S03 D26 d25 L200	VRT2811	26	25	200	3	₺2.370
SPXN 06H - S04 D33 d32 L200	VRT2812	33	32	200	4	₺2.553

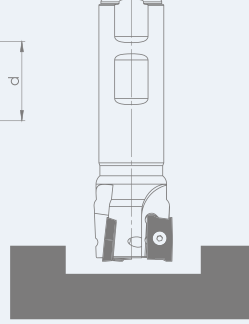
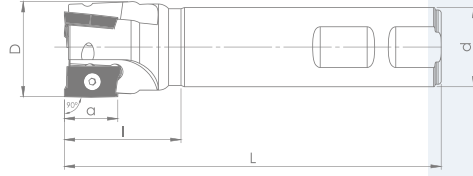

TEKNİK ÇİZİM / TECHNICAL DRAWING

TAKIM KODU ORDERING CODE	ÜRÜN KODU PRODUCT CODE	KATER ÖLÇÜLERİ DIMENSIONS (mm)	KESİCİ UÇ INSERT	TL FİYAT TL PRICE
-----------------------------	---------------------------	-----------------------------------	---------------------	----------------------

**SPAP 11R390 90°**

D	d	L
---	---	---

 KESİCİ UÇ ADET  
INSERT QTY

SPAP11R390 - S02 D16 d16 L100	VRT2813	16	16	100
SPAP11R390 - S02 D18 d16 L100	VRT2814	18	16	100
SPAP11R390 - S03 D20 d20 L100	VRT2815	20	20	100
SPAP11R390 - S03 D25 d25 L100	VRT2816	25	25	100
SPAP11R390 - S04 D30 d25 L100	VRT2817	30	25	100
SPAP11R390 - S02 D16 d16 L120	VRT2818	16	16	120
SPAP11R390 - S02 D18 d16 L120	VRT2819	18	16	120
SPAP11R390 - S03 D20 d20 L120	VRT2820	20	20	120
SPAP11R390 - S03 D25 d25 L120	VRT2821	25	25	120
SPAP11R390 - S04 D30 d25 L120	VRT2822	30	25	120
SPAP11R390 - S02 D16 d16 L150	VRT2823	16	16	150
SPAP11R390 - S02 D18 d16 L150	VRT2824	18	16	150
SPAP11R390 - S03 D20 d20 L150	VRT2825	20	20	150
SPAP11R390 - S03 D25 d25 L150	VRT2826	25	25	150
SPAP11R390 - S04 D30 d25 L150	VRT2827	30	25	150
SPAP11R390 - S02 D16 d16 L200	VRT3501	16	16	200
SPAP11R390 - S03 D20 d20 L200	VRT3502	20	20	200
SPAP11R390 - S03 D25 d25 L200	VRT3503	25	25	200

**AP.. 11  
R390**
**2**
**2**
**3**
**3**
**4**
**2**
**2**
**3**
**3**
**4**
**2**
**2**
**3**
**3**
**4**
**2**
**3**
**3**

₺926

₺1.037

₺1.037

₺1.082

₺1.249

₺1.035

₺1.148

₺1.148

₺1.183

₺1.348

₺1.114

₺1.348

₺1.348

₺1.381

₺1.564

₺1.300

₺1.516

₺1.564

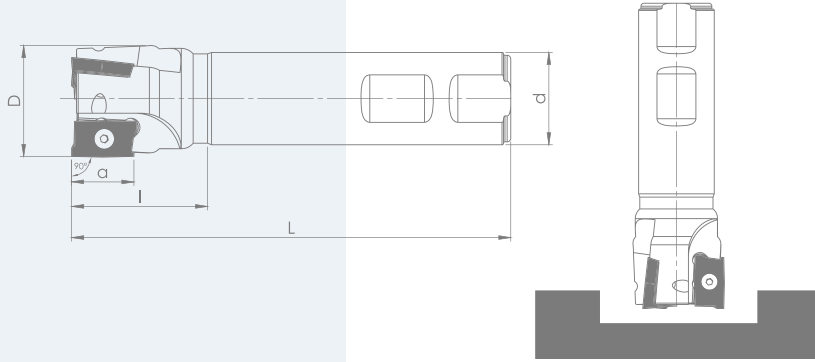

TEKNİK ÇİZİM / TECHNICAL DRAWING

TAKIM KODU ORDERING CODE	ÜRÜN KODU PRODUCT CODE	KATER ÖLÇÜLERİ DIMENSIONŞ (mm)	KESİCİ UÇ INSERT	TL FİYAT TL PRICE
-----------------------------	---------------------------	-----------------------------------	---------------------	----------------------

**SPAP 17R390**

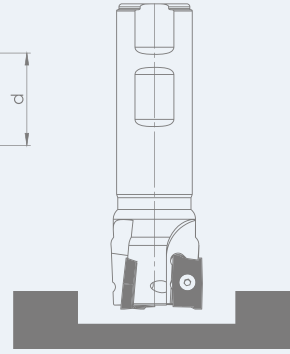
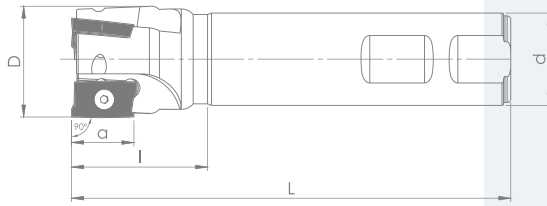

		D	d	L	KESİCİ UÇ ADET INSERT QTY		
SPAP17R390 - S02 D25 d25 L100	VRT2832	25	25	100	2		₺982
SPAP17R390 - S03 D30 d25 L100	VRT2833	30	25	100	3		₺1.009
SPAP17R390 - S03 D32 d25 L100	VRT2834	32	25	100	3		₺1.100
SPAP17R390 - S02 D25 d25 L120	VRT2835	25	25	120	2		₺1.035
SPAP17R390 - S03 D30 d25 L120	VRT2836	30	25	120	3	<b>AP.. 17 R390</b>	₺1.100
SPAP17R390 - S03 D32 d25 L120	VRT2837	32	25	120	3		₺1.121
SPAP17R390 - S02 D25 d25 L150	VRT2838	25	25	150	2		₺1.357
SPAP17R390 - S03 D30 d25 L150	VRT2839	30	25	150	3		₺1.414
SPAP17R390 - S03 D32 d25 L150	VRT2840	32	25	150	3		₺1.440



TEKNİK ÇİZİM / TECHNICAL DRAWING

TAKIM KODU ORDERING CODE	ÜRÜN KODU PRODUCT CODE	KATER ÖLÇÜLERİ DIMENSIONS (mm)	KESİCİ UÇ INSERT	TL FİYAT TL PRICE
-----------------------------	---------------------------	-----------------------------------	---------------------	----------------------

**SPAP 1135 90°**

		D	d	L	KESİCİ UÇ ADET INSERT QTY		
SPAP1135 - S02 D16 d16 L100	VRT2841	16	16	100	2		₺926
SPAP1135 - S03 D20 d20 L100	VRT2842	20	20	100	3		₺1.037
SPAP1135 - S03 D25 d25 L100	VRT2843	25	25	100	3		₺1.082
SPAP1135 - S02 D16 d16 L120	VRT2844	16	16	120	2		₺1.035
SPAP1135 - S03 D20 d20 L120	VRT2845	20	20	120	3		₺1.148
SPAP1135 - S03 D25 d25 L120	VRT2846	25	25	120	3		₺1.183
SPAP1135 - S02 D16 d16 L150	VRT2847	16	16	150	2		₺1.114
SPAP1135 - S03 D20 d20 L150	VRT2848	20	20	150	3	AP.. 1135	₺1.346
SPAP1135 - S03 D25 d25 L150	VRT2849	25	25	150	3		₺1.381
SPAP1135 - S02 D16 d16 L200	VRT2850	16	16	200	2		₺1.346
SPAP1135 - S03 D20 d20 L200	VRT2851	20	20	200	3		₺1.516
SPAP1135 - S03 D25 d25 L200	VRT2852	25	25	200	3		₺1.559
SPAP1135 - S02 D17 d16 L150	VRT2853	17	16	150	2		₺1.114
SPAP1135 - S03 D21 d20 L150	VRT2854	21	20	150	3		₺1.364
SPAP1135 - S03 D26 d25 L150	VRT2855	26	25	150	3		₺1.398

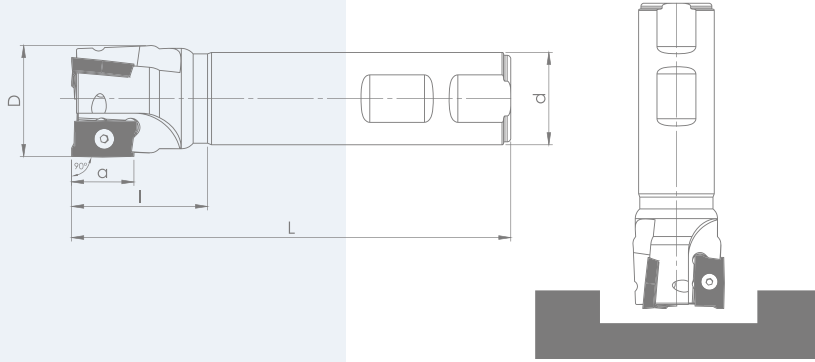

TEKNİK ÇİZİM / TECHNICAL DRAWING

TAKIM KODU ORDERING CODE	ÜRÜN KODU PRODUCT CODE	KATER ÖLÇÜLERİ DIMENSIONŞ (mm)	KESİCİ UÇ INSERT	TL FİYAT TL PRICE
-----------------------------	---------------------------	-----------------------------------	---------------------	----------------------

**SPAP 11 T3 90°**

D	d	L
---	---	---

KESİCİ UÇ ADET  
INSERT QTY



AP..  
11T3

SPAP11T3 - S02 D16 d16 L100	VRT2856	16 16 100	2	₺926
SPAP11T3 - S03 D20 d20 L100	VRT2857	20 20 100	3	₺1.037
SPAP11T3 - S03 D25 d25 L100	VRT2858	25 25 100	3	₺1.082
SPAP11T3 - S02 D16 d16 L120	VRT2859	16 16 120	2	₺1.035
SPAP11T3 - S03 D20 d20 L120	VRT2860	20 20 120	3	₺1.148
SPAP11T3 - S03 D25 d25 L120	VRT2861	25 25 120	3	₺1.183
SPAP11T3 - S02 D16 d16 L150	VRT2862	16 16 150	2	₺1.114
SPAP11T3 - S03 D20 d20 L150	VRT2863	20 20 150	3	₺1.346
SPAP11T3 - S03 D25 d25 L150	VRT2864	25 25 150	3	₺1.373
SPAP11T3 - S02 D16 d16 L200	VRT2865	16 16 200	2	₺1.283
SPAP11T3 - S03 D20 d20 L200	VRT2866	20 20 200	3	₺1.516
SPAP11T3 - S03 D25 d25 L200	VRT2867	25 25 200	3	₺1.559

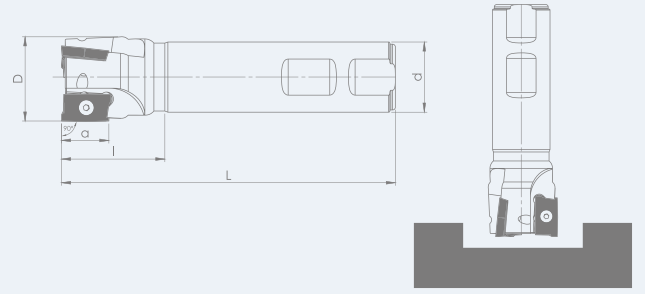

TEKNİK ÇİZİM / TECHNICAL DRAWING

TAKIM KODU ORDERING CODE	ÜRÜN KODU PRODUCT CODE	KATER ÖLÇÜLERİ DIMENSIONS (mm)	KESİCİ UÇ INSERT	TL FİYAT TL PRICE
-----------------------------	---------------------------	-----------------------------------	---------------------	----------------------

**SPLO03**

		D	d	L
SPLO03 - S02 D16 D16 L150H	VRT2828	16	16	130
SPLO03 - S03 D20 D20 L150H	VRT2829	20	20	150
SPLO03 - S04 D25 D25 L150H	VRT2830	25	25	150
SPLO03 - S05 D32 D32 L150H	VRT2831	32	32	150

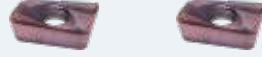
 KESİCİ UÇ ADET  
INSERT QTY

**1**

₺1.391

**3**

₺1.504

**4**

₺1.798

**5**

₺1.923

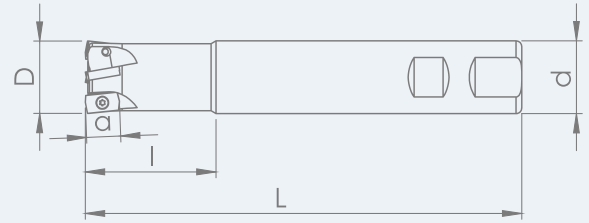
**LGO. 0310**

TEKNİK ÇİZİM / TECHNICAL DRAWING

TAKIM KODU ORDERING CODE	ÜRÜN KODU PRODUCT CODE	KATER ÖLÇÜLERİ DIMENSIONS (mm)	KESİCİ UÇ INSERT	TL FİYAT TL PRICE
-----------------------------	---------------------------	-----------------------------------	---------------------	----------------------

**SPBL06**

		D	d	L
SPBL06 - S02 D17 D16 L150H	VRT2797	17	16	150
SPBL06 - S02 D16 D16 L200H	VRT3504	16	16	150
SPBL06 - S02 D16 D16 L250H	VRT3505	16	16	150
SPBL06 - S03 D21 D20 L150H	VRT2798	21	20	150
SPBL06 - S04 D26 D25 L150H	VRT2799	26	25	150
SPBL06 - S05 D32 D32 L150H	VRT2800	32	31	150

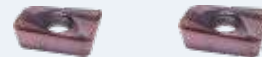
 KESİCİ UÇ ADET  
INSERT QTY

**2**

₺1.255

**2**

₺1.412

**2**

₺1.931

**3**

₺1.347

**4**

₺1.634

**5**

₺1.923

**BLM. 0603**

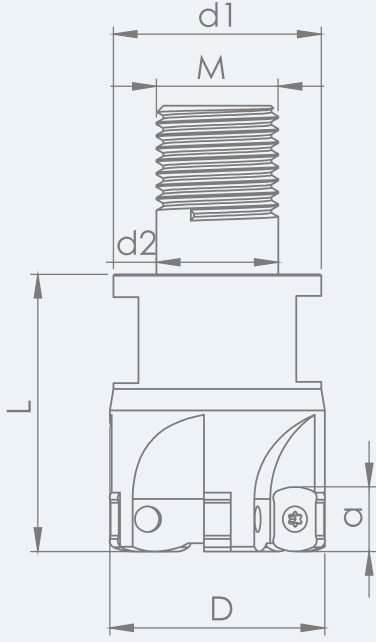

**TEKNİK ÇİZİM / TECHNICAL DRAWING**

**TAKIM KODU**  
ORDERING CODE



**ÜRÜN KODU**  
PRODUCT CODE

**KATER ÖLÇÜLERİ**  
DIMENSIONS (mm)

**KESİCİ UÇ**  
INSERT

**TL FİYAT**  
TL PRICE

**VMFBL06**

		D	d2	d1	L	M	KESİCİ UÇ ADET INSERT QTY		
VMFBL06 - 16M08-Z02	VRT2888	16	8.5	14,5	25	08	2		
VMFBL06 - 20M10-Z03	VRT2889	20	10.5	18	30	10	3		
VMFBL06 - 25M12-Z04	VRT2890	25	12.5	23	30	12	4	<b>BL.. 06</b>	
VMFBL06 - 32M16-Z05	VRT2891	32	17	29	40	16	5		
VMFBL06 - 35M16-Z05	VRT2892	35	17	29	40	16	5		
									<b>₺1.868</b>
									<b>₺2.041</b>
									<b>₺2.176</b>
									<b>₺2.370</b>
									<b>₺2.370</b>

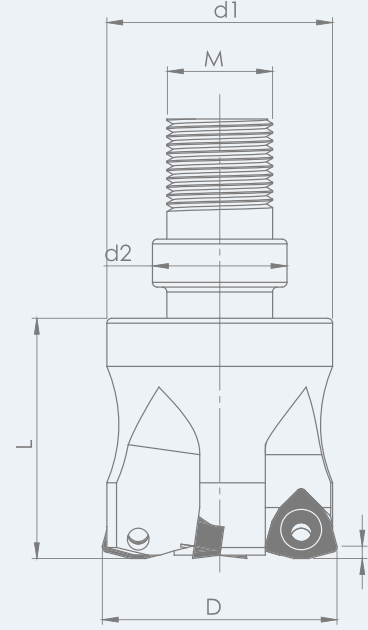

TEKNİK ÇİZİM / TECHNICAL DRAWING

TAKIM KODU ORDERING CODE	ÜRÜN KODU PRODUCT CODE	KATER ÖLÇÜLERİ DIMENSIONS (mm)					KESİCİ UÇ INSERT	TL FİYAT TL PRICE
HRMDM		D	d2	d1	L	M	KESİCİ UÇ ADET INSERT QTY	
HRMDM - 0616 HR-M08 Z02	VRT2872	16	8,5	14,5	25	M08	2	₺2.049
HRMDM - 0617 HR-M08 Z02	VRT2873	17	8,5	14,5	25	M08	2	₺2.049
HRMDM - 0620 HR-M10 Z02	VRT2874	20	10,5	18	30	M10	2	₺2.244
HRMDM - 0621 HR-M10 Z02	VRT2875	21	10,5	18	30	M10	2	₺2.244
HRMDM - 0625 HR-M12 Z03	VRT2876	25	12,5	23	30	M12	3	₺2.393
HRMDM - 0626 HR-M12 Z03	VRT2877	26	12,5	23	30	M12	3	₺2.393
HRMDM - 0925 HR-M12 Z02	VRT2878	25	12,5	23	30	M12	2	₺2.393
HRMDM - 0926 HR-M12 Z02	VRT2879	26	12,5	23	30	M12	2	₺2.393
HRMDM - 0935 HR-M16 Z04	VRT2880	35	17	29	40	M16	4	₺2.582
HRMDM - 0940 HR-M16 Z04	VRT2881	40	17	29	40	M16	4	₺2.582
HRMDM - 0942 HR-M16 Z04	VRT2882	42	17	29	40	M16	4	₺2.582

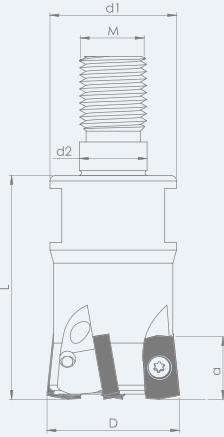

TEKNİK ÇİZİM / TECHNICAL DRAWING

**TAKIM KODU**  
ORDERING CODE

**ÜRÜN KODU**  
PRODUCT CODE

**KATER ÖLÇÜLERİ**  
DIMENSIONS (mm)

**KESİCİ UÇ**  
INSERT

**TL FİYAT**  
TL PRICE
**MFHLO**

		D	d2	d1	L	M
MFHLO - 25 M12-104T Z02	VRT2883	25	12,5	23	30	M12
MFHLO - 32 M16-104T Z03	VRT2884	32	17	29	40	M16
MFHLO - 40 M16-104T Z04	VRT2885	40	17	29	40	M16

KESİCİ UÇ ADET  
INSERT QTY

2

LO.. 10

3

4

₺2.393

₺2.582

₺2.582

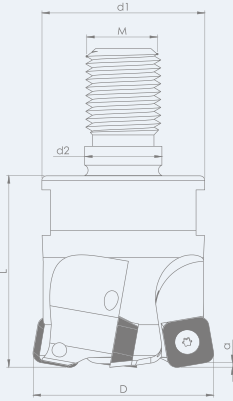

TEKNİK ÇİZİM / TECHNICAL DRAWING

**TAKIM KODU**  
ORDERING CODE

**ÜRÜN KODU**  
PRODUCT CODE

**KATER ÖLÇÜLERİ**  
DIMENSIONS (mm)

**KESİCİ UÇ**  
INSERT

**TL FİYAT**  
TL PRICE
**MFHSO**

		D	d2	d1	L	M
MFHSO - 32 M16-104T Z03	VRT2886	32	17	29	40	M16
MFHSO - 40 M16-104T Z04	VRT2887	40	17	29	40	M16

KESİCİ UÇ ADET  
INSERT QTY

3

SO.. 10

4

₺2.582

₺2.582

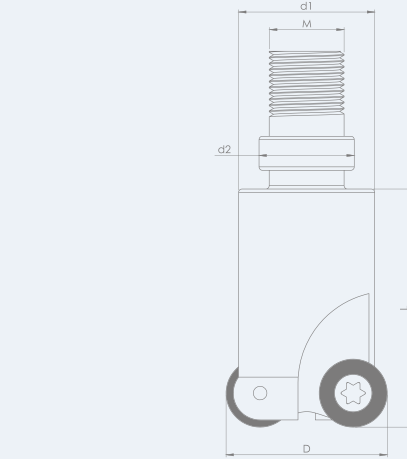

TEKNİK ÇİZİM / TECHNICAL DRAWING

 TAKIM KODU  
ORDERING CODE

 ÜRÜN KODU  
PRODUCT CODE

 KATER ÖLÇÜLERİ  
DIMENSIONS (mm)

 KESİCİ UÇ  
INSERT

 TL FİYAT  
TL PRICE

**VMF RD10**

		D	d2	d1	L	M
VMF RD10 - 25 H M12 Z03	VRT2896	25	12,5	22	30	M12
VMF RD10 - 30 H M16 Z04	VRT2897	30	17	27	40	M16
VMF RD10 - 35 H M16 Z04	VRT2898	35	17	27	40	M16

 KESİCİ UÇ ADET  
INSERT QTY

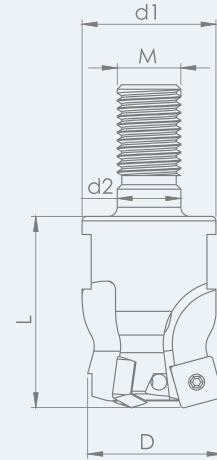
**3**
**4**
**4**
**RD..  
1003**
**₺1.750**
**₺1.868**
**₺1.989**

TEKNİK ÇİZİM / TECHNICAL DRAWING

 TAKIM KODU  
ORDERING CODE

 ÜRÜN KODU  
PRODUCT CODE

 KATER ÖLÇÜLERİ  
DIMENSIONS (mm)

 KESİCİ UÇ  
INSERT

 TL FİYAT  
TL PRICE

**VMF SD09**

		D	d2	d1	L	M
VMF SD09 - 25 H M12 Z02	VRT2899	25	12,5	22	30	M12
VMF SD09 - 32 H M16 Z02	VRT2900	32	17	27	40	M16
VMF SD09 - 40 H M16 Z04	VRT2901	40	17	27	40	M16

 KESİCİ UÇ ADET  
INSERT QTY

**2**
**2**
**4**
**SD.. 09T3**
**₺2.393**
**₺2.692**
**₺2.744**

[www.vorgen.com](http://www.vorgen.com)

**VORGEN®**

# DELİK DELME VE TORNALAMA

HOLE DRILL AND LATHE

**NEW COATING  
TECHNOLOGY**



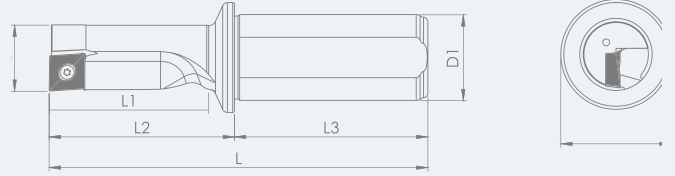

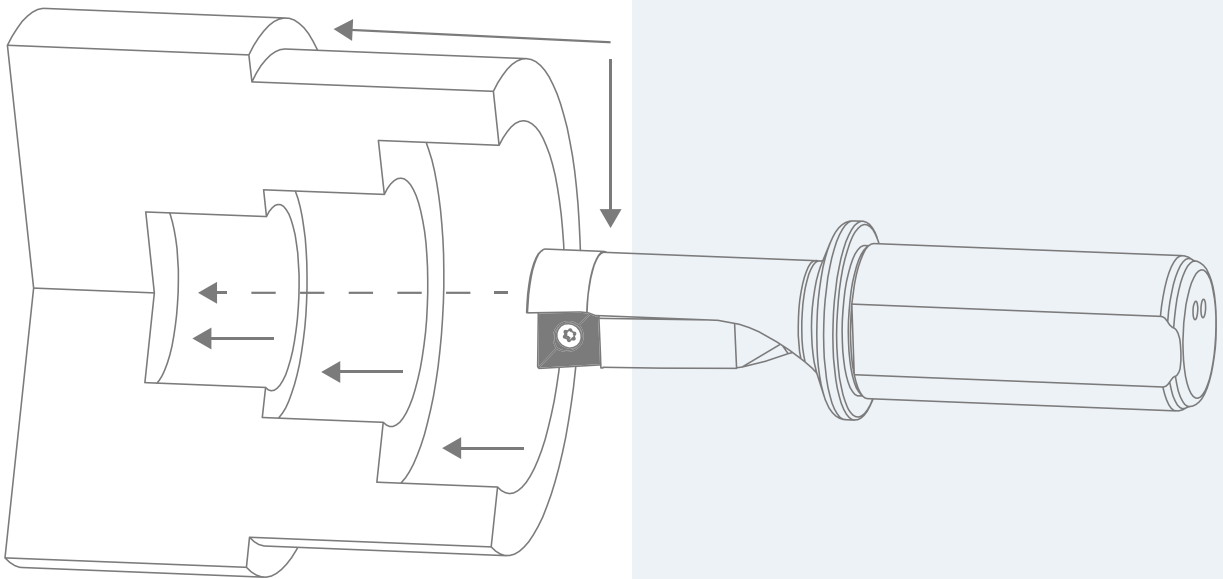

## TEKNİK ÇİZİM / TECHNICAL DRAWING

TAKIM KODU ORDERING CODE	ÜRÜN KODU PRODUCT CODE	KATER ÖLÇÜLERİ DIMENSIONS (mm)							KESİCİ UÇ INSERT	TL FİYAT TL PRICE
BTMT		L	L1	L2	L3	D	D1	D2		
BTMT - 10Rx2,25D	VRT2902	72	22,5	30	42	10	12	16	<b>XC.. 030204</b>	₺1.868
BTMT - 12Rx2,25D	VRT2903	78	27	33	45	12	16	20	<b>XC.. 060304</b>	₺1.868
BTMT - 14Rx2,25D	VRT2904	83	31,5	38	45	14	16	20	<b>XC.. 070304</b>	₺2.018
BTMT - 16Rx2,25D	VRT2905	94	36	44	50	16	20	25	<b>XC.. 080304</b>	₺2.079
BTMT - 20Rx2,25D	VRT2906	111	45	55	56	20	25	32	<b>XC.. 10T304</b>	₺2.574
BTMT - 25Rx2,25D	VRT2907	129	56,5	69	60	25	32	40	<b>XC.. 130404</b>	₺2.877

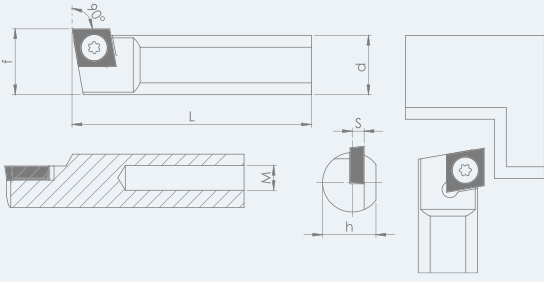



TEKNİK ÇİZİM / TECHNICAL DRAWING

TAKIM KODU ORDERING CODE	ÜRÜN KODU PRODUCT CODE	KATER ÖLÇÜLERİ DIMENSIONS (mm)	KESİCİ UÇ INSERT	TL FİYAT TL PRICE							
<b>SCGCR</b>	<b>90°</b>	<b>Sol Left</b>	<b>Sağ Right</b>	<b>d</b>	<b>h</b>	<b>L</b>	<b>S</b>	<b>f</b>	<b>M</b>		
S10A - SCGCR/L - 06	VRT3506	VRT2908	10	9	32	1	10	M5			₺579
S10B - SCGCR/L - 06	VRT3507	VRT2909	10	9	40	1	10	M5			₺579
S10C - SCGCR/L - 06	VRT3508	VRT2910	10	9	50	1	10	M5			₺579
S12A - SCGCR/L - 06	VRT3509	VRT2911	12	11	32	1	12	M5		<b>CC.. 0602</b>	₺660
S12B - SCGCR/L - 06	VRT3510	VRT2912	12	11	40	1	12	M5			₺660
S12C - SCGCR/L - 06	VRT3511	VRT2913	12	11	50	1	12	M5			₺660
S16A - SCGCR/L - 09	VRT3512	VRT2914	16	16	32	2	16	M6x1			₺725
S16B - SCGCR/L - 09	VRT3513	VRT2915	16	16	40	2	16	M6x1			₺725
S16C - SCGCR/L - 09	VRT3514	VRT2916	16	16	50	2	16	M6x1		<b>CC.. 09T3</b>	₺725
S16D - SCGCR/L - 09	VRT3514	VRT2916	16	16	60	2	16	M6x1			₺819



**NEW COATING  
TECHNOLOGY**

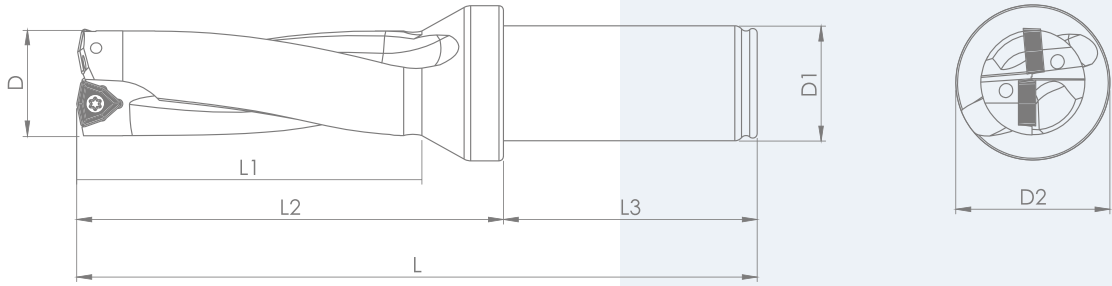

TEKNİK ÇİZİM / TECHNICAL DRAWING

 TAKIM KODU  
ORDERING CODE

 ÜRÜN KODU  
PRODUCT CODE

 KATER ÖLÇÜLERİ  
DIMENSIONS (mm)

 KESİCİ UÇ  
INSERT

 TL FİYAT  
TL PRICE

**BTDR 2D WCM**

L	L1	L2	L3	D	D1	D2
---	----	----	----	---	----	----



BTDR - 2Dx16	VRU2938	108	32	52	56	16	25	34
BTDR - 2Dx16,5	VRU2939	108	32	52	56	16,5	25	34
BTDR - 2Dx17	VRU2940	110	34	54	56	17	25	34
BTDR - 2Dx17,5	VRU2941	110	34	54	56	17,5	25	34
BTDR - 20x18	VRU2942	112	36	56	56	18	25	34
BTDR - 2Dx18,5	VRU2943	112	36	56	56	18,5	25	34
BTDR - 2Dx19	VRU2944	114	38	58	56	19	25	34
BTDR - 2Dx19,5	VRU2945	114	38	58	56	19,5	25	34
BTDR - 2Dx20	VRU2946	116	40	60	56	20	25	34
BTDR - 2Dx20,5	VRU2947	116	40	60	56	20,5	25	34
BTDR - 2Dx21	VRU2948	118	42	62	56	21	25	34
BTDR - 2Dx21,5	VRU2949	118	42	62	56	21,5	25	34
BTDR - 2Dx22	VRU2950	120	44	64	56	22	25	34
BTDR - 2Dx22,5	VRU2951	120	44	64	56	22,5	25	34
BTDR - 2Dx23	VRU2952	122	46	66	56	23	25	34
BTDR - 2Dx23,5	VRU2953	122	46	66	56	23,5	25	34

 WCM..  
030208

₺2.135

₺2.135

₺2.135

₺2.135

₺2.135

₺2.135

₺2.135

₺2.135

₺2.370

₺2.370

₺2.370

 WCM..  
040208

₺2.370

₺2.370

₺2.370

₺2.370

₺2.370



**TAKIM KODU**  
ORDERING CODE

**ÜRÜN KODU**  
PRODUCT CODE

**KATER ÖLÇÜLERİ**  
DIMENSIONS (mm)

**KESİCİ UÇ**  
INSERT

**TL FİYAT**  
TL PRICE

**BTDR 2D WCM**

L	L1	L2	L3	D	D1	D2
---	----	----	----	---	----	----



BTDR - 2Dx24	VRU2954	124	48	68	56	24	25	34
BTDR - 2Dx24,5	VRU2955	124	48	68	56	24,5	25	34
BTDR - 2Dx25	VRU2956	126	50	70	56	25	25	34
BTDR - 2Dx25,5	VRU2957	126	50	70	56	25,5	25	34
BTDR - 2Dx26	VRU2958	128	52	72	56	26	25	34
BTDR - 2Dx26,5	VRU2959	128	52	72	56	26,5	25	34
BTDR - 2Dx27	VRU2960	130	54	74	56	27	25	34
BTDR - 2Dx27,5	VRU2961	130	54	74	56	27,5	25	34
BTDR - 2Dx28	VRU2962	132	56	76	56	28	25	34
BTDR - 2Dx28,5	VRU2963	132	56	76	56	28,5	25	34
BTDR - 2Dx29	VRU2964	134	58	78	56	29	25	34
BTDR - 2Dx29,5	VRU2965	134	58	78	56	29,5	25	34
BTDR - 2Dx30	VRU2966	145	60	85	60	30	32	44
BTDR - 2Dx31	VRU2967	147	62	87	60	31	32	44
BTDR - 2Dx32	VRU2968	149	64	89	60	32	32	44
BTDR - 2Dx33	VRU2969	151	66	91	60	33	32	44
BTDR - 2Dx34	VRU2970	153	68	93	60	34	32	44
BTDR - 2Dx35	VRU2971	155	70	95	60	35	32	44
BTDR - 2Dx36	VRU2972	157	72	97	60	36	32	44
BTDR - 2Dx37	VRU2973	159	74	99	60	37	32	44
BTDR - 2Dx38	VRU2974	161	76	101	60	38	32	44
BTDR - 2Dx39	VRU2975	163	78	103	60	39	32	44
BTDR - 2Dx40	VRU2976	165	80	105	60	40	32	44
BTDR - 2Dx41	VRU2977	167	82	107	60	41	32	44
BTDR - 2Dx42	VRU2978	169	84	109	60	42	32	44
BTDR - 2Dx43	VRU2979	171	86	111	60	43	32	44
BTDR - 2Dx44	VRU2980	173	88	113	60	44	32	44
BTDR - 2Dx45	VRU2981	190	90	120	70	45	40	54
BTDR - 2Dx46	VRU2982	192	92	122	70	46	40	54
BTDR - 2Dx47	VRU2983	194	94	124	70	47	40	54
BTDR - 2Dx48	VRU2984	196	96	126	70	48	40	54
BTDR - 2Dx49	VRU2985	198	98	128	70	49	40	54
BTDR - 2Dx50	VRU2986	200	100	130	70	50	40	54
BTDR - 2Dx51	VRU2987	202	102	132	70	51	40	54
BTDR - 2Dx52	VRU2988	204	104	134	70	52	40	54
BTDR - 2Dx53	VRU2989	206	106	136	70	53	40	54
BTDR - 2Dx54	VRU2990	208	108	138	70	54	40	54
BTDR - 2Dx55	VRU2991	210	110	140	70	55	40	54
BTDR - 2Dx56	VRU2992	212	112	142	70	56	40	64
BTDR - 2Dx57	VRU2993	214	114	144	70	57	40	64
BTDR - 2Dx58	VRU2994	216	116	146	70	58	40	64
BTDR - 2Dx59	VRU2995	218	118	148	70	59	40	64
BTDR - 2Dx60	VRU2996	220	120	150	70	60	40	64

**WCM..**  
**050308**
**WCM..**  
**06T308**
**WCM..**  
**080412**

₺2.474

₺2.474

₺2.474

₺2.474

₺2.474

₺2.474

₺2.474

₺2.474

₺2.474

₺2.474

₺2.474

₺2.474

₺2.596

₺2.596

₺2.596

₺2.596

₺2.596

₺2.596

₺2.596

₺2.731

₺2.731

₺2.731

₺2.731

₺2.731

₺2.731

₺2.731

₺2.731

₺2.919

₺3.130

₺3.263

₺3.296

₺3.340

₺3.370

₺3.549

₺3.671

₺3.821

₺3.874

₺4.052

₺4.298

₺4.460

₺4.627

₺4.796

₺4.906

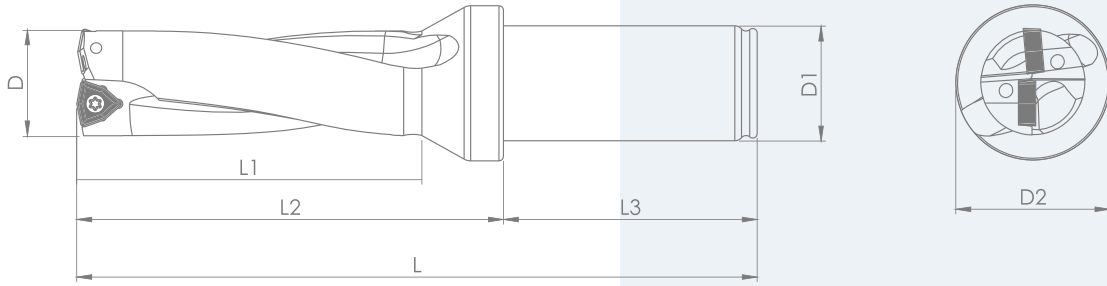

TEKNİK ÇİZİM / TECHNICAL DRAWING

 TAKIM KODU  
ORDERING CODE

 ÜRÜN KODU  
PRODUCT CODE

 KATER ÖLÇÜLERİ  
DIMENSIONS (mm)

 KESİCİ UÇ  
INSERT

 TL FİYAT  
TL PRICE

**BTDR 3D WCM**

	L	L1	L2	L3	D	D1	D2
BTDR - 3Dx16	124	48	68	56	16	25	34
BTDR - 3Dx16,5	124	48	68	56	16,5	25	34
BTDR - 3Dx17	127	51	71	56	17	25	34
BTDR - 3Dx17,5	127	51	71	56	17,5	25	34
BTDR - 3Dx18	130	54	74	56	18	25	34
BTDR - 3Dx18,5	130	54	74	56	18,5	25	34
BTDR - 3Dx19	133	57	77	56	19	25	34
BTDR - 3Dx19,5	133	57	77	56	19,5	25	34
BTDR - 3Dx20	136	60	80	56	20	25	34
BTDR - 3Dx20,5	136	60	80	56	20,5	25	34
BTDR - 3Dx21	139	63	83	56	21	25	34
BTDR - 3Dx21,5	139	63	83	56	21,5	25	34
BTDR - 3Dx22	142	66	86	56	22	25	34
BTDR - 3Dx22,5	142	66	86	56	22,5	25	34
BTDR - 3Dx23	145	69	89	56	23	25	34
BTDR - 3Dx23,5	145	69	89	56	23,5	25	34

 WCM..  
03 02 08

 WCM..  
04 02 08

₺2.311

₺2.311

₺2.311

₺2.311

₺2.311

₺2.311

₺2.311

₺2.311

₺2.396

₺2.396

₺2.396

₺2.396

₺2.396

₺2.396

₺2.396

₺2.396

**TAKIM KODU**  
ORDERING CODE

**ÜRÜN KODU**  
PRODUCT CODE

**KATER ÖLÇÜLERİ**  
DIMENSIONS (mm)

**Kesici uç**  
INSERT

**TL FİYAT**  
TL PRICE

**BTDR 3D WCM**

L	L1	L2	L3	D	D1	D2
---	----	----	----	---	----	----

WCM..  
05 03 08

WCM..  
06 T3 08

WCM..  
08 04 12

BTDR - 3Dx24	VRU3013	148	72	92	56	24	25	34	₺2.486
BTDR - 3Dx24,5	VRU3014	148	72	92	56	24,5	25	34	₺2.486
BTDR - 3Dx25	VRU3015	151	75	95	56	25	25	34	₺2.486
BTDR - 3Dx25,5	VRU3016	151	75	95	56	25,5	25	34	₺2.486
BTDR - 3Dx26	VRU3017	154	78	98	56	26	25	34	₺2.486
BTDR - 3Dx26,5	VRU3018	154	78	98	56	26,5	25	34	₺2.486
BTDR - 3Dx27	VRU3019	157	81	101	56	27	25	34	₺2.486
BTDR - 3Dx27,5	VRU3020	157	81	101	56	27,5	25	34	₺2.486
BTDR - 3Dx28	VRU3021	160	84	104	56	28	25	34	₺2.486
BTDR - 3Dx28,5	VRU3022	160	84	104	56	28,5	25	34	₺2.486
BTDR - 3Dx29	VRU3023	163	87	107	56	29	25	34	₺2.486
BTDR - 3Dx29,5	VRU3024	163	87	107	56	29,5	25	34	₺2.486
BTDR - 3Dx30	VRU3025	171	90	115	56	30	32	44	₺2.582
BTDR - 3Dx30,5	VRU3246	171	90	115	56	30,5	32	44	₺2.582
BTDR - 3Dx31	VRU3026	178	93	118	60	31	32	44	₺2.582
BTDR - 3Dx31,5	VRU3247	178	93	118	60	31,5	32	44	₺2.582
BTDR - 3Dx32	VRU3027	181	96	121	60	32	32	44	₺2.582
BTDR - 3Dx32,5	VRU3248	181	96	121	60	32,5	32	44	₺2.582
BTDR - 3Dx33	VRU3028	184	99	124	60	33	32	44	₺2.582
BTDR - 3Dx33,5	VRU3249	184	99	124	60	33,5	32	44	₺2.582
BTDR - 3Dx34	VRU3029	187	102	127	60	34	32	44	₺2.582
BTDR - 3Dx34,5	VRU3250	187	102	127	60	34,5	32	44	₺2.582
BTDR - 3Dx35	VRU3030	190	105	130	60	35	32	44	₺2.666
BTDR - 3Dx35,5	VRU3251	190	105	130	60	35,5	32	44	₺2.666
BTDR - 3Dx36	VRU3031	193	108	133	60	36	32	44	₺2.666
BTDR - 3Dx36,5	VRU3252	193	108	133	60	36,5	32	44	₺2.666
BTDR - 3Dx37	VRU3032	196	111	136	60	37	32	44	₺2.666
BTDR - 3Dx37,5	VRU3253	196	111	136	60	37,5	32	44	₺2.666
BTDR - 3Dx38	VRU3033	199	114	139	60	38	32	44	₺2.666
BTDR - 3Dx38,5	VRU3254	199	114	139	60	38,5	32	44	₺2.666
BTDR - 3Dx39	VRU3034	201	117	141	60	39	32	44	₺2.666
BTDR - 3Dx39,5	VRU3255	201	117	141	60	39,5	32	44	₺2.666
BTDR - 3Dx40	VRU3035	204	120	144	60	40	32	44	₺2.821
BTDR - 3Dx40,5	VRU3256	204	120	144	60	40,5	32	44	₺2.821
BTDR - 3Dx41	VRU3036	207	123	147	60	41	32	44	₺2.821
BTDR - 3Dx41,5	VRU3257	207	123	147	60	41,5	32	44	₺2.821
BTDR - 3Dx42	VRU3037	210	126	150	60	42	32	44	₺2.821
BTDR - 3Dx42,5	VRU3258	210	126	150	60	42,5	32	44	₺2.821
BTDR - 3Dx43	VRU3038	213	129	153	60	43	32	44	₺2.821
BTDR - 3Dx43,5	VRU3259	213	129	153	60	43,5	32	44	₺2.821
BTDR - 3Dx44	VRU3039	216	132	156	60	44	32	44	₺2.821
BTDR - 3Dx44,5	VRU3260	216	132	156	60	44,5	32	44	₺2.821
BTDR - 3Dx45	VRU3040	234	135	164	70	45	40	54	₺2.919
BTDR - 3Dx45,5	VRU3261	234	135	164	70	45	40	54	₺2.919
BTDR - 3Dx46	VRU3041	237	138	167	70	46	40	54	₺2.919
BTDR - 3Dx47	VRU3042	240	141	170	70	47	40	54	₺2.919
BTDR - 3Dx48	VRU3043	243	144	173	70	48	40	54	₺2.919
BTDR - 3Dx49	VRU3044	246	147	176	70	49	40	54	₺3.370
BTDR - 3Dx50	VRU3045	249	150	179	70	50	40	54	₺3.370
BTDR - 3Dx51	VRU3046	252	153	182	70	51	40	54	₺3.728
BTDR - 3Dx52	VRU3047	255	156	185	70	52	40	54	₺3.931
BTDR - 3Dx53	VRU3048	258	159	188	70	53	40	54	₺4.120
BTDR - 3Dx54	VRU3049	261	162	191	70	54	40	54	₺4.272
BTDR - 3Dx55	VRU3050	264	165	194	70	55	40	54	₺4.488
BTDR - 3Dx56	VRU3051	267	168	197	70	56	40	64	₺4.573
BTDR - 3Dx57	VRU3052	270	171	200	70	57	40	64	₺4.688
BTDR - 3Dx58	VRU3053	273	174	203	70	58	40	64	₺4.918
BTDR - 3Dx59	VRU3054	276	177	206	70	59	40	64	₺5.069
BTDR - 3Dx60	VRU3055	279	180	209	70	60	40	64	₺5.142



TEKNİK ÇİZİM / TECHNICAL DRAWING

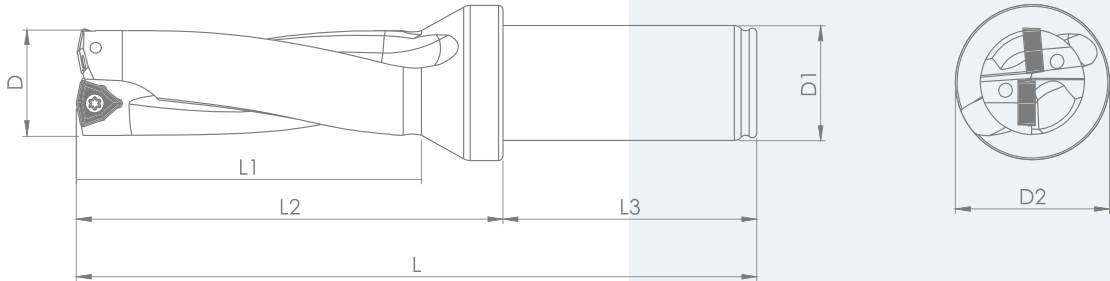



TAKIM KODU ORDERING CODE	ÜRÜN KODU PRODUCT CODE	KATER ÖLÇÜLERİ DIMENSIONS (mm)							KESİCİ UÇ INSERT	TL FİYAT TL PRICE
-----------------------------	---------------------------	-----------------------------------	--	--	--	--	--	--	---------------------	----------------------

<b>BTDR 4D WCM</b>		L	L1	L2	L3	D	D1	D2			
BTDR - 4Dx16	VRU3056	140	64	84	56	16	25	34	 <b>WCM.. 030208</b>	₺2.908	
BTDR - 4Dx16,5	VRU3057	140	64	84	56	16,5	25	34		₺2.908	
BTDR - 4Dx17	VRU3058	144	68	88	56	17	25	34		₺2.908	
BTDR - 4Dx17,5	VRU3059	144	68	88	56	17,5	25	34		₺2.908	
BTDR - 4Dx18	VRU3060	148	72	92	56	18	25	34		₺2.908	
BTDR - 4Dx18,5	VRU3061	148	72	92	56	18,5	25	34		₺2.908	
BTDR - 4Dx19	VRU3062	152	76	96	56	19	25	34		₺2.908	
BTDR - 4Dx19,5	VRU3063	152	76	96	56	19,5	25	34		₺2.908	
BTDR - 4Dx20	VRU3064	156	80	100	56	20	25	34		<b>WCM.. 040208</b>	₺3.125
BTDR - 4Dx20,5	VRU3065	156	80	100	56	20,5	25	34			₺3.125
BTDR - 4Dx21	VRU3066	160	84	104	56	21	25	34	₺3.125		
BTDR - 4Dx21,5	VRU3067	160	84	104	56	21,5	25	34	₺3.125		
BTDR - 4Dx22	VRU3068	164	88	108	56	22	25	34	₺3.125		
BTDR - 4Dx22,5	VRU3069	164	88	108	56	22,5	25	34	₺3.125		
BTDR - 4Dx23	VRU3070	168	92	112	56	23	25	34	₺3.125		
BTDR - 4Dx23,5	VRU3071	168	92	112	56	23,5	25	34	₺3.125		
BTDR - 4Dx24	VRU3072	172	96	116	56	24	25	44	<b>WCM.. 050308</b>		₺3.296
BTDR - 4Dx24,5	VRU3073	172	96	116	56	24,5	25	44			₺3.296
BTDR - 4Dx25	VRU3074	176	100	120	56	25	25	44		₺3.296	
BTDR - 4Dx25,5	VRU3075	176	100	120	56	25,5	25	44		₺3.296	
BTDR - 4Dx26	VRU3076	180	104	124	56	26	25	44		₺3.296	
BTDR - 4Dx26,5	VRU3077	180	104	124	56	26,5	25	44		₺3.296	
BTDR - 4Dx27	VRU3078	184	108	128	56	27	25	44		₺3.296	
BTDR - 4Dx27,5	VRU3079	184	108	128	56	27,5	25	44		₺3.296	
BTDR - 4Dx28	VRU3080	188	112	132	56	28	25	44		₺3.296	
BTDR - 4Dx28,5	VRU3081	188	112	132	56	28,5	25	44		₺3.296	
BTDR - 4Dx29	VRU3082	192	116	136	56	29	25	44	<b>WCM.. 06T308</b>	₺3.296	
BTDR - 4Dx29,5	VRU3083	192	116	136	56	29,5	25	44		₺3.296	
BTDR - 4Dx30	VRU3084	205	120	145	60	30	32	44		₺3.500	
BTDR - 4Dx31	VRU3085	209	124	149	60	31	32	44		₺3.500	
BTDR - 4Dx32	VRU3086	213	128	153	60	32	32	44		₺3.500	
BTDR - 4Dx33	VRU3087	217	132	157	60	33	32	44		₺3.500	
BTDR - 4Dx34	VRU3088	221	136	161	60	34	32	44		₺3.500	
BTDR - 4Dx35	VRU3089	225	140	165	60	35	32	44		₺3.500	
BTDR - 4Dx36	VRU3090	229	144	169	60	36	32	44		₺3.500	
BTDR - 4Dx37	VRU3091	233	148	173	60	37	32	44		₺3.500	
BTDR - 4Dx38	VRU3092	237	152	177	60	38	32	44	₺3.531		
BTDR - 4Dx39	VRU3093	241	156	181	60	39	32	44	₺3.531		
BTDR - 4Dx40	VRU3094	245	160	185	60	40	32	44	₺3.531		
BTDR - 4Dx41	VRU3095	249	164	189	60	41	32	44	₺3.531		
BTDR - 4Dx42	VRU3096	253	168	193	60	42	32	44	₺3.531		
BTDR - 4Dx43	VRU3097	257	172	197	60	43	32	44	₺3.531		
BTDR - 4Dx44	VRU3098	261	176	201	60	44	32	44	₺3.531		
BTDR - 4Dx45	VRU3262	280	180	210	70	45	40	54	<b>WCM.. 080412</b>	₺3.692	
BTDR - 4Dx46	VRU3263	284	184	214	70	46	40	54		₺4.004	
BTDR - 4Dx47	VRU3264	288	188	218	70	47	40	54		₺4.316	
BTDR - 4Dx48	VRU3265	292	192	222	70	48	40	54		₺4.524	
BTDR - 4Dx49	VRU3266	296	196	226	70	49	40	54		₺4.888	
BTDR - 4Dx50	VRU3267	300	200	230	70	50	40	54		₺5.148	

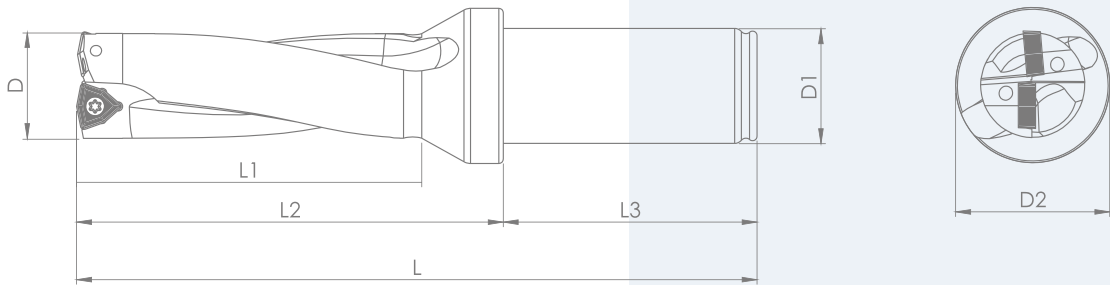

**TEKNİK ÇİZİM / TECHNICAL DRAWING**



TAKIM KODU ORDERING CODE	ÜRÜN KODU PRODUCT CODE	KATER ÖLÇÜLERİ DIMENSIONS (mm)							KESİCİ UÇ INSERT	TL FİYAT TL PRICE
<b>BTDR 5D WCM</b>		L	L1	L2	L3	D	D1	D2		
BTDR - 5Dx16	VRU3099	156	80	100	56	16	25	34	 <b>WCM.. 030208</b>	₺3.587
BTDR - 5Dx17	VRU3100	161	85	105	56	17	25	34		₺3.587
BTDR - 5Dx18	VRU3101	166	90	110	56	18	25	34		₺3.587
BTDR - 5Dx19	VRU3102	171	95	115	56	19	25	34		₺3.818
BTDR - 5Dx20	VRU3103	176	100	120	56	20	25	34	<b>WCM.. 040208</b>	₺3.818
BTDR - 5Dx21	VRU3104	181	105	125	56	21	25	34		₺3.818
BTDR - 5Dx22	VRU3105	186	110	130	56	22	25	34		₺3.818
BTDR - 5Dx23	VRU3106	191	115	135	56	23	25	34		₺3.818
BTDR - 5Dx24	VRU3107	196	120	140	56	24	25	34	<b>WCM.. 050308</b>	₺3.818
BTDR - 5Dx25	VRU3108	201	125	145	56	25	25	34		₺3.818
BTDR - 5Dx26	VRU3109	206	130	150	56	26	25	34		₺3.818
BTDR - 5Dx27	VRU3110	211	135	155	56	27	25	34		₺3.818
BTDR - 5Dx28	VRU3111	216	140	160	56	28	25	34		₺3.818
BTDR - 5Dx29	VRU3112	221	145	165	56	29	25	34		₺3.818
BTDR - 5Dx30	VRU3113	235	150	175	60	30	32	44	<b>WCM.. 06T308</b>	₺3.818
BTDR - 5Dx31	VRU3114	240	155	180	60	31	32	44		₺4.133
BTDR - 5Dx32	VRU3115	245	160	185	60	32	32	44		₺4.133
BTDR - 5Dx33	VRU3116	250	165	190	60	33	32	44		₺4.133
BTDR - 5Dx34	VRU3117	255	170	195	60	34	32	44		₺4.133
BTDR - 5Dx35	VRU3239	260	175	200	60	35	32	44		₺4.316
BTDR - 5Dx36	VRU3240	265	180	205	60	36	32	44		₺4.524
BTDR - 5Dx37	VRU3241	270	185	210	60	37	32	44		₺4.680
BTDR - 5Dx38	VRU3242	275	190	215	60	38	32	44		₺4.888

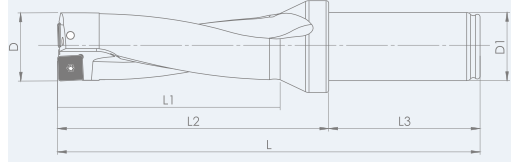

TEKNİK ÇİZİM / TECHNICAL DRAWING

TAKIM KODU ORDERING CODE	ÜRÜN KODU PRODUCT CODE	TAKIM ÖLÇÜLERİ DIMENSIONS (mm)	KESİCİ UÇ INSERT	TL FİYAT TL PRICE
-----------------------------	---------------------------	-----------------------------------	---------------------	----------------------

**BTDR 2D SPMG**

L	L1	L2	L3	D	D1	D2
96	26	46	50	13	20	25
96	26	46	50	13,5	20	25
98	28	48	50	14	20	25
98	28	48	50	14,5	20	25
100	30	50	50	15	20	25
100	30	50	50	15,5	20	25
108	32	52	56	16	25	34
108	32	52	56	16,5	25	34
110	34	54	56	17	25	34
110	34	54	56	17,5	25	34
112	36	56	56	18	25	34
112	36	56	56	18,5	25	34
114	38	58	56	19	25	34
114	38	58	56	19,5	25	34
116	40	60	56	20	25	34
116	40	60	56	20,5	25	34
118	42	62	56	21	25	34
118	42	62	56	21,5	25	34

 SP..  
050204

 SP..  
060204

₺2.257

₺2.257

₺2.257

₺2.257

₺2.257

₺2.257

₺2.135

₺2.135

₺2.135

₺2.135

₺2.257

₺2.135

₺2.135

₺2.135

₺2.370

₺2.370

₺2.370

₺2.370



TAKIM KODU ORDERING CODE	ÜRÜN KODU PRODUCT CODE	KATER ÖLÇÜLERİ DIMENSIONS (mm)						KESİCİ UÇ INSERT	TL FİYAT TL PRICE
-----------------------------	---------------------------	-----------------------------------	--	--	--	--	--	---------------------	----------------------

**BTDR 2D SPMG**

L	L1	L2	L3	D	D1	D2
---	----	----	----	---	----	----



BTDR - 2Dx22	VRU3136	120	44	64	56	22	25	34	SP.. 07T0308	₺2.370
BTDR - 2Dx22,5	VRU3137	120	44	64	56	22,5	25	34		₺2.370
BTDR - 2Dx23	VRU3138	122	46	66	56	23	25	34		₺2.370
BTDR - 2Dx23,5	VRU3139	122	46	66	56	23,5	25	34		₺2.370
BTDR - 2Dx24	VRU3140	124	48	68	56	24	25	34		₺2.474
BTDR - 2Dx24,5	VRU3141	124	48	68	56	24,5	25	34		₺2.474
BTDR - 2Dx25	VRU3142	126	50	70	56	25	25	34		₺2.474
BTDR - 2Dx25,5	VRU3143	126	50	70	56	25,5	25	34		₺2.474
BTDR - 2Dx26	VRU3144	128	52	72	56	26	25	34		₺2.474
BTDR - 2Dx26,5	VRU3145	128	52	72	56	26,5	25	34		₺2.474
BTDR - 2Dx27	VRU3146	130	54	74	56	27	25	34	₺2.474	
BTDR - 2Dx27,5	VRU3147	130	54	74	56	27,5	25	34	₺2.474	
BTDR - 2Dx28	VRU3148	132	56	76	56	28	25	34	SP.. 090408	₺2.474
BTDR - 2Dx28,5	VRU3149	132	56	76	56	28,5	25	34		₺2.474
BTDR - 2Dx29	VRU3150	134	58	78	56	29	25	34		₺2.474
BTDR - 2Dx29,5	VRU3151	134	58	78	56	29,5	25	34		₺2.474
BTDR - 2Dx30	VRU3152	145	60	85	60	30	32	44		₺2.596
BTDR - 2Dx31	VRU3153	147	62	87	60	31	32	44		₺2.596
BTDR - 2Dx32	VRU3154	149	64	89	60	32	32	44		₺2.596
BTDR - 2Dx33	VRU3155	151	66	91	60	33	32	44	₺2.596	
BTDR - 2Dx34	VRU3156	153	68	93	60	34	32	44	₺2.596	
BTDR - 2Dx35	VRU3157	155	70	95	60	35	32	44	₺2.596	
BTDR - 2Dx36	VRU3158	157	72	97	60	36	32	44	₺2.596	
BTDR - 2Dx37	VRU3159	159	74	99	60	37	32	44	SP.. 110408	₺2.731
BTDR - 2Dx38	VRU3160	161	76	101	60	38	32	44		₺2.731
BTDR - 2Dx39	VRU3161	163	78	103	60	39	32	44		₺2.731
BTDR - 2Dx40	VRU3162	165	80	105	60	40	32	44		₺2.731
BTDR - 2Dx41	VRU3163	167	82	107	60	41	32	44		₺2.731
BTDR - 2Dx42	VRU3268	169	84	109	60	42	32	44	SP.. 140512	₺2.731
BTDR - 2Dx43	VRU3269	171	86	111	60	43	32	44		₺2.731
BTDR - 2Dx44	VRU3270	173	88	113	60	44	32	44		₺2.731
BTDR - 2Dx45	VRU3271	190	90	120	70	45	32	54		₺2.919
BTDR - 2Dx46	VRU3272	192	92	122	70	46	32	54		₺3.130
BTDR - 2Dx47	VRU3273	194	94	124	70	47	32	54		₺3.263
BTDR - 2Dx48	VRU3274	196	96	126	70	48	32	54		₺3.296
BTDR - 2Dx49	VRU3275	198	98	128	70	49	32	54		₺3.340
BTDR - 2Dx50	VRU3276	200	100	130	70	50	32	54		₺3.370

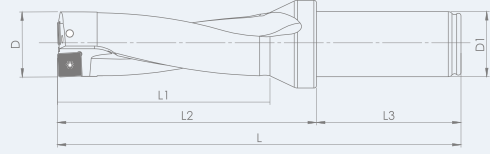

TEKNİK ÇİZİM / TECHNICAL DRAWING

TAKIM KODU ORDERING CODE	ÜRÜN KODU PRODUCT CODE	TAKIM ÖLÇÜLERİ DIMENSIONS (mm)	KESİCİ UÇ INSERT	TL FİYAT TL PRICE
-----------------------------	---------------------------	-----------------------------------	---------------------	----------------------

**BTDR 3D SPMG**

L	L1	L2	L3	D	D1	D2
---	----	----	----	---	----	----

 SP..  
050204

 SP..  
060204

BTDR - 3Dx13	VRU3164	109	39	59	50	13	20	25
BTDR - 3Dx13,5	VRU3165	109	39	59	50	13,5	20	25
BTDR - 3Dx14	VRU3166	112	42	62	50	14	20	25
BTDR - 3Dx14,5	VRU3167	112	42	62	50	14,5	20	25
BTDR - 3Dx15	VRU3168	115	45	65	50	15	20	25
BTDR - 3Dx15,5	VRU3169	115	45	65	50	15,5	20	25
BTDR - 3Dx16	VRU3170	124	48	68	56	16	25	3
BTDR - 3Dx16,5	VRU3171	124	48	68	56	16,5	25	3
BTDR - 3Dx17	VRU3172	127	51	71	56	17	25	34
BTDR - 3Dx17,5	VRU3173	127	51	71	56	17,5	25	34
BTDR - 3Dx18	VRU3174	130	54	74	56	18	25	34
BTDR - 3Dx18,5	VRU3175	130	54	74	56	18,5	25	34
BTDR - 3Dx19	VRU3176	133	57	77	56	19	25	34
BTDR - 3Dx19,5	VRU3177	133	57	77	56	19,5	25	34
BTDR - 3Dx20	VRU3178	136	60	80	56	20	25	34
BTDR - 3Dx20,5	VRU3179	136	60	80	56	20,5	25	34
BTDR - 3Dx21	VRU3180	139	63	83	56	21	25	34
BTDR - 3Dx21,5	VRU3181	139	63	83	56	21,5	25	34

₺2.311

₺2.311

₺2.311

₺2.311

₺2.311

₺2.311

₺2.311

₺2.311

₺2.311

₺2.311

₺2.311

₺2.311

₺2.311

₺2.311

₺2.396

₺2.396

₺2.396

₺2.396

TAKIM KODU ORDERING CODE	ÜRÜN KODU PRODUCT CODE	KATER ÖLÇÜLERİ DIMENSIONS (mm)						KESİCİ UÇ INSERT	TL FİYAT TL PRICE
-----------------------------	---------------------------	-----------------------------------	--	--	--	--	--	---------------------	----------------------

**BTDR 3D SPMG**

L	L1	L2	L3	D	D1	D2
---	----	----	----	---	----	----



BTDR - 3Dx22	VRU3182	142	66	86	56	22	25	34	SP.. 07T0308	₺2.396
BTDR - 3Dx22,5	VRU3183	142	66	86	56	22,5	25	34		₺2.396
BTDR - 3Dx23	VRU3184	145	69	89	56	23	25	34		₺2.396
BTDR - 3Dx23,5	VRU3185	145	69	89	56	23,5	25	34		₺2.396
BTDR - 3Dx24	VRU3186	148	72	92	56	24	25	34		₺2.486
BTDR - 3Dx24,5	VRU3187	148	72	92	56	24,5	25	34		₺2.486
BTDR - 3Dx25	VRU3188	151	75	95	56	25	25	34		₺2.486
BTDR - 3Dx25,5	VRU3189	151	75	95	56	25,5	25	34		₺2.486
BTDR - 3Dx26	VRU3190	154	78	98	56	26	25	34		₺2.486
BTDR - 3Dx26,5	VRU3191	154	78	98	56	26,5	25	34		₺2.486
BTDR - 3Dx27	VRU3192	157	81	101	56	27	25	34		₺2.486
BTDR - 3Dx27,5	VRU3193	157	81	101	56	27,5	25	34		₺2.486
BTDR - 3Dx28	VRU3194	160	84	104	56	28	25	34	SP.. 090408	₺2.486
BTDR - 3Dx28,5	VRU3195	160	84	104	56	28,5	25	34		₺2.486
BTDR - 3Dx29	VRU3196	163	87	107	56	29	25	34		₺2.486
BTDR - 3Dx29,5	VRU3197	163	87	107	56	29,5	25	34		₺2.486
BTDR - 3Dx30	VRU3198	175	90	115	60	30	32	44		₺2.582
BTDR - 3Dx31	VRU3199	178	93	118	60	31	32	44		₺2.582
BTDR - 3Dx32	VRU3200	181	96	121	60	32	32	44		₺2.582
BTDR - 3Dx33	VRU3201	184	99	124	60	33	32	44	₺2.582	
BTDR - 3Dx34	VRU3202	187	102	127	60	34	32	44	SP.. 110408	₺2.582
BTDR - 3Dx35	VRU3203	190	105	130	60	35	32	44		₺2.666
BTDR - 3Dx36	VRU3204	193	108	133	60	36	32	44		₺2.666
BTDR - 3Dx37	VRU3205	196	111	136	60	37	32	44		₺2.666
BTDR - 3Dx38	VRU3206	199	114	139	60	38	32	44		₺2.666
BTDR - 3Dx39	VRU3207	202	117	142	60	39	32	44		₺2.666
BTDR - 3Dx40	VRU3208	205	120	145	60	40	32	44		₺2.821
BTDR - 3Dx41	VRU3209	208	123	148	60	41	32	44		₺2.821



**TEKNİK ÇİZİM / TECHNICAL DRAWING**

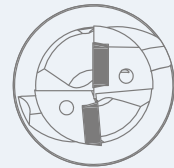
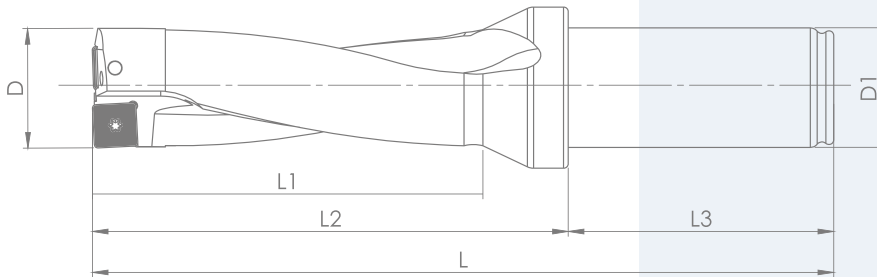

TAKIM KODU ORDERING CODE	ÜRÜN KODU PRODUCT CODE	KATER ÖLÇÜLERİ DIMENSIONS (mm)						KESİCİ UÇ INSERT	TL FİYAT TL PRICE	
<b>BTDR 4D SPMG</b>		L	L1	L2	L3	D	D1	D2		
BTDR - 4Dx13	VRU3210	122	52	72	50	13	20	25	SP.. 050204	₺2.976
BTDR - 4Dx14	VRU3211	126	56	76	50	14	20	25	SP.. 050204	₺2.976
BTDR - 4Dx15	VRU3212	130	60	80	50	15	20	25	SP.. 050204	₺2.976
BTDR - 4Dx16	VRU3213	140	64	84	56	16	25	34	SP.. 060204	₺2.908
BTDR - 4Dx17	VRU3214	144	68	88	56	17	25	34	SP.. 060204	₺2.908
BTDR - 4Dx18	VRU3215	148	72	92	56	18	25	34	SP.. 060204	₺2.908
BTDR - 4Dx19	VRU3216	152	76	96	56	19	25	34	SP.. 060204	₺2.908
BTDR - 4Dx20	VRU3217	156	80	100	56	20	25	34	SP.. 060204	₺3.125
BTDR - 4Dx21	VRU3218	160	84	104	56	21	25	34	SP.. 060204	₺3.125
BTDR - 4Dx22	VRU3219	164	88	108	56	22	25	34	SP.. 07T308	₺3.125
BTDR - 4Dx23	VRU3220	168	92	112	56	23	25	34	SP.. 07T308	₺3.125
BTDR - 4Dx24	VRU3221	172	96	116	56	24	25	34	SP.. 07T308	₺3.296
BTDR - 4Dx25	VRU3222	176	100	120	56	25	25	34	SP.. 07T308	₺3.296
BTDR - 4Dx26	VRU3223	180	104	124	56	26	25	34	SP.. 07T308	₺3.296
BTDR - 4Dx27	VRU3224	184	108	128	56	27	25	34	SP.. 07T308	₺3.296
BTDR - 4Dx28	VRU3225	188	112	132	56	28	25	34	SP.. 090408	₺3.296
BTDR - 4Dx29	VRU3226	192	116	136	56	29	25	34	SP.. 090408	₺3.296
BTDR - 4Dx30	VRU3227	205	120	145	60	30	32	44	SP.. 090408	₺3.500
BTDR - 4Dx31	VRU3228	209	124	149	60	31	32	44	SP.. 090408	₺3.500
BTDR - 4Dx32	VRU3229	213	128	153	60	32	32	44	SP.. 090408	₺3.500
BTDR - 4Dx33	VRU3230	217	132	157	60	33	32	44	SP.. 090408	₺3.500
BTDR - 4Dx34	VRU3231	221	136	161	60	34	32	44	SP.. 110408	₺3.500
BTDR - 4Dx35	VRU3232	225	140	165	60	35	32	44	SP.. 110408	₺3.500
BTDR - 4Dx36	VRU3233	229	144	169	60	36	32	44	SP.. 110408	₺3.500
BTDR - 4Dx37	VRU3234	233	148	173	60	37	32	44	SP.. 110408	₺3.500
BTDR - 4Dx38	VRU3235	237	152	177	60	38	32	44	SP.. 110408	₺3.531
BTDR - 4Dx39	VRU3236	241	156	181	60	39	32	44	SP.. 110408	₺3.531
BTDR - 4Dx40	VRU3237	245	160	185	60	40	32	44	SP.. 110408	₺3.531
BTDR - 4Dx41	VRU3238	249	164	189	60	41	32	44	SP.. 110408	₺3.531



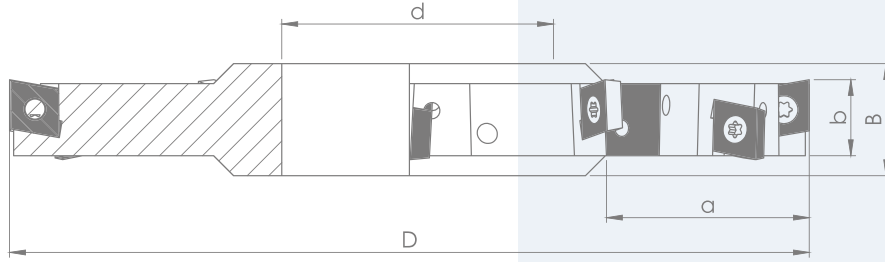

TEKNİK ÇİZİM / TECHNICAL DRAWING

TAKIM KODU ORDERING CODE	ÜRÜN KODU PRODUCT CODE	TAKIM ÖLÇÜLERİ DIMENSIONS (mm)	Kesici uç INSERT	TL FİYAT TL PRICE
-----------------------------	---------------------------	-----------------------------------	---------------------	----------------------

VRDF	Z	Z1	D	b	a	d	B		
VRDF - D80x8 - d27-Z10	10	5	80	8	17	27	12	CC.. 0602	₺3.064
VRDF - D100x8 - d32-Z12	12	6	100	8	25	32	12		₺3.644
VRDF - D125x8 - d40-Z14	14	7	125	8	35	40	12		₺5.611
VRDF - D80x10 - d27-Z10	10	5	80	10	17	27	14		₺3.064
VRDF - D100x10 - d32-Z12	12	6	100	10	25	32	14		₺3.644
VRDF - D125x10 - d40-Z14	14	7	125	10	35	40	14		₺5.611
VRDF - D80x12 - d27-Z08	8	4	80	12	17	27	16	CC.. 09T3	₺3.064
VRDF - D100x12 - d32-Z10	10	5	100	12	25	32	16		₺3.644
VRDF - D125x12 - d40-Z12	12	6	125	12	35	40	16		₺5.611
VRDF - D80x14 - d27-Z08	8	4	80	14	17	27	18		₺3.064
VRDF - D100x14 - d32-Z10	10	5	100	14	25	32	18		₺3.644
VRDF - D125x14 - d40-Z12	12	6	125	14	35	40	18		₺5.611
VRDF - D80x16 - d27-Z06	6	3	80	16	17	27	20	CC.. 1204	₺3.064
VRDF - D100x16 - d32-Z08	8	4	100	16	25	32	20		₺3.644
VRDF - D125x16 - d40-Z10	10	5	125	16	35	40	20		₺5.611
VRDF - D80x18 - d27-Z06	6	3	80	18	17	27	22		₺3.064
VRDF - D100x18 - d32-Z08	8	4	100	18	25	32	22		₺3.644
VRDF - D125x18 - d40-Z10	10	5	125	18	35	40	22		₺5.611
VRDF - D80x20 - d27-Z06	6	3	80	20	17	27	24	₺3.064	
VRDF - D100x20 - d32-Z08	8	4	100	20	25	32	24	₺3.644	
VRDF - D125x20 - d40-Z10	10	5	125	20	35	40	24	₺5.611	

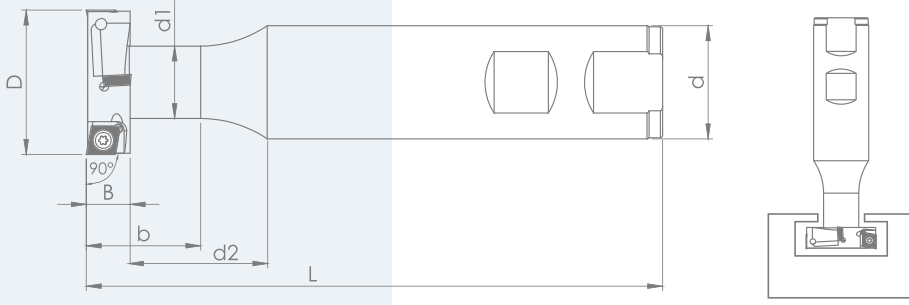

TEKNİK ÇİZİM / TECHNICAL DRAWING

**TAKIM KODU**  
ORDERING CODE

**ÜRÜN KODU**  
PRODUCT CODE

**TAKIM ÖLÇÜLERİ**  
DIMENSIONS (mm)

**KESİCİ UÇ**  
INSERT

**TL FİYAT**  
TL PRICE
**SPTF**

		Z	Z1	D	B	d7	L	D1	D2
SPTF - D17x8 - d16 - Z02 - L100	VRU3239	2	1	17	8	16	100	10	16
SPTF - D20x9 - d16 - Z04 - L100	VRU3240	4	2	20	9	16	100	10	16
SPTF - D25x11 - d20 - Z04 - L100	VRU3241	4	2	25	11	25	100	13	20
SPTF - D32x12 - d25 - Z04 - L100	VRU3242	4	2	32	12	25	100	16	25
SPTF - D35x15 - d25 - Z04 - L100	VRU3243	4	2	35	15	25	100	17	30
SPTF - D40x17 - d32 - Z04 - L120	VRU3244	4	2	40	17	32	120	19	30
SPTF - D50x22 - d32 - Z04 - L120	VRU3245	4	2	50	22	32	120	25	45
SPTF - D52x21 - d32 - Z04 - L120	VRU3246	4	2	52	21	32	120	25	45



CC.. 0602

CC.. 09T3

CC.. 1204

₺1.443

₺1.443

₺1.589

₺1.737

₺1.825

₺1.868

₺1.923

₺1.923

[www.vorgen.com](http://www.vorgen.com)



# YEDEK PARÇALAR

SPARE PARTS





**BASKI PAPUÇLARI / WEDGE CLAMP**

ÜRÜN KODU ORDER CODE	TL FİYAT TL PRICE	ÜRÜN DETAYI DETAILS PRODUCT	ÜRÜN RESMİ PRODUCT OF PICTURE
VDP 01	₺87	D SİSTEM İÇİN DNMG 11, WNMG 06, TNMG 16	
VDP 02	₺87	D SİSTEM İÇİN TNMG22, DNMG 15, CNMG 12, SNMG12, WNM 08,	
VDP 03	₺87	D SİSTEM İÇİN VNMG 16	
VDP 04	₺87	D SİSTEM İÇİN CNMG16, SNMG 15	
VDP 05	₺95	D SİSTEM İÇİN CNMG 19, SNG 19	
VMP 01	₺86	M SİSTEM İÇİN WNMG 06	
VMP02	₺86	M SİSTEM İÇİN WNMG 08	
VMP 03	₺86	M SİSTEM İÇİN TNMG 16	
VMP 04	₺87	M SİSTEM İÇİN TNMG 22	
VCP 01	₺87	C SİSTEM İÇİN KNUX-R (ORJİNAL)	
VCP 02	₺87	C SİSTEM İÇİN KNUX-L (ORJİNAL)	
VCP 03	₺86	C SİSTEM İÇİN 154.91, IR 16, ER 16, IR 22, ER 22, TPKN 16	
VCP 04	₺86	C SİSTEM İÇİN TPKN 22	
VCP 05	₺78	C SİSTEM İÇİN KNUX-R	
VCP 06	₺78	C SİSTEM İÇİN KNUX-L	
VCP 07	₺86	C SİSTEM İÇİN SERAMİK CNGN, SNGM, DNGN	
VKP 01	₺86	BKT-R390 İÇİN R390 HRN	
VSP 01	₺99	SPKN TAR. İÇİN SPKN SET	

## ALTLIKLAR / SHIMS

ÜRÜN KODU ORDER CODE	TL FİYAT TL PRICE	ÜRÜN DETAYI DETAILS PRODUCT	ÜRÜN RESMİ PRODUCT OF PICTURE
VRTC 16	₺87	S SİSTEM İÇİN TCMT 16	
VRTN 16	₺87	D SİSTEM İÇİN M SİSTEM İÇİN TNMG 16	
VRTN 22	₺95	D SİSTEM İÇİN M SİSTEM İÇİN TNMG 22	
VRTN 2202	₺95	S25S M SİSTEM İÇİN TNMG 22	
VRIR 16	₺95	VİDA 16 ALTLIK IR 16, ER 16	
VRIR 22	₺99	VİDA 22 ALTLIK IR 22, ER 22	
VRCM 09	₺87	S SİSTEM İÇİN CCMT 09	
VRCN 12	₺95	D SİSTEM İÇİN C SİSTEM İÇİN CNMG 12, CNGN 12	
VRCN 16	₺176	D SİSTEM İÇİN CNMG 16	
VRCN 19	₺183	D SİSTEM İÇİN CNMG 19	
VRWN 08	₺87	D SİSTEM İÇİN M SİSTEM İÇİN WNMG 08	
VRKN 16L	₺92	C SİSTEM İÇİN KNUX-L 16	
VRKN 16R	₺92	C SİSTEM İÇİN KNUX-R 16	
VRSC 12	₺86	S SİSTEM İÇİN SCMT 12	
VRSN 12	₺87	D SİSTEM İÇİN C SİSTEM İÇİN SNMG 12, SNMN 12	
VRTP 22	₺108	TP 22 TAR. İÇİN TPKN 22	









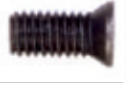

**ALTIKLAR / SHIMS**

ÜRÜN KODU ORDER CODE	TL FİYAT TL PRICE	ÜRÜN DETAYI DETAILS PRODUCT	ÜRÜN RESMİ PRODUCT OF PICTURE
VRSN 15	₺176	D SİSTEM İÇİN SNMG 15	
VRSN 19	₺183	D SİSTEM İÇİN SNMG 19	
VRDC 11	₺87	S SİSTEM İÇİN D SİSTEM İÇİN DNMG 11, DCMT 11	
VRDN 15	₺87	D SİSTEM İÇİN DNMG 15	
VRVB 16	₺87	S SİSTEM İÇİN D SİSTEM İÇİN VBMT 16, VCMT 16, VNMG 16	

**BASKI PAPUÇ VİDALARI / CLAMP SCREW**

ÜRÜN KODU ORDER CODE	TL FİYAT TL PRICE	ÜRÜN DETAYI DETAILS PRODUCT	ÜRÜN RESMİ PRODUCT OF PICTURE
VRV 01-M5	₺45	D SİSTEM İÇİN M SİSTEM İÇİN DNMG 11, TNMG 16, WNMG 06	
VRV 02-M6	₺45	D SİSTEM İÇİN M SİSTEM İÇİN CNMG 12, TNMG 22, DNMG 15, SNMG 12, TNMG 22, VNMG 16, WNMG 08	
VRV 03-M6	₺45	D SİSTEM İÇİN CNMG 19, SNMG 15, SNMG 19, CNMG 16	
VRV 04-M6	₺45	C SİSTEM İÇİN KNUX 16	
VRV 05-M8	₺46	C SİSTEM İÇİN DNGN, TNGN, SNGN	
VRV 001-M6	₺45	TARAMA İÇİN TPKN 16	
VRV 002-M8	₺45	TARAMA İÇİN TPKN 22	
VRV 003-M8	₺46	TARAMA İÇİN SPKN 12 (SOL)	
VRV 06-M8	₺46	KANAL KATERİ İÇİN JD, HTN, KRY, SD S123, ZCC..	

**ALTLIK VİDALARI / SHIMS SCREWS**

ÜRÜN KODU ORDER CODE	TL FİYAT TL PRICE	ÜRÜN DETAYI DETAILS PRODUCT	ÜRÜN RESMİ PRODUCT OF PICTURE
VAV 01-M3	₺34	C SİSTEM İÇİN KNUX 16	
VAV 02-M5	₺34	D SİSTEM İÇİN DNMG 15, SNMG 12, TNMG 22, WNMG 08, CNMG 12	
VAV 03-M4	₺34	D SİSTEM İÇİN DNMG 11	
VAV 04-M5	₺34	D SİSTEM İÇİN CNMG 16, SNMG 15	
VAV 05-M6	₺34	D SİSTEM İÇİN CNMG 19, SNMG 19	
VAV 06-M5.05	₺41	S SİSTEM İÇİN VBMT 16, ER 16, IR 16, TCMT 16, CCMT 09, DCMT 11, VCMT 16, BUKSE VİDA 3,5	
VAV 07-M6	₺46	S SİSTEM İÇİN ER 22, SCMT 12, BUKSE VİDA 4,5	
VAV 08-M5	₺45	M SİSTEM İÇİN TNMG 16, WNMG 06	
VAV 09-M5	₺45	M SİSTEM İÇİN S 20, MTUNR 16 İÇİN VİDALI PİM	
VAV 10-M6	₺45	M SİSTEM İÇİN WNMG 08, TNMG 22	
VTP 005	₺55	TIRTIR İÇİN	

**BASKI YAY / SPRING**

ÜRÜN KODU ORDER CODE	TL FİYAT TL PRICE	ÜRÜN DETAYI DETAILS PRODUCT	ÜRÜN RESMİ PRODUCT OF PICTURE
VRY 01	₺28	D SİSTEM İÇİN WNMG 16, WNMG 08, TNMG 22, DNMG 15, CNMG 12	
VRY 02	₺28	C SİSTEM İÇİN KNUX 16	







**YEDEK PARÇALARDA İSKONTO ORANI FARKLIDIR.**  
DISCOUNT RATES ARE DIFFERENT FOR SPARE PARTS

TORX VİDALARI / TORX SCREWS

ÜRÜN KODU ORDER CODE	TL FİYAT TL PRICE	ÜRÜN DETAYI DETAILS PRODUCT	ÜRÜN RESMİ PRODUCT OF PICTURE
VRT 01-M2x5	₺46		
VRT 02-M2,2x5	₺46		
VRT 03-M2,5x5	₺32		
VRT 04-M2,5x5	₺32		
VRT 05-M3x8	₺32		
VRT 06-M3,5x9	₺32		
VRT 07-M3,5x11	₺34		
VRT 08-M3,5x16	₺34		
VRT 09-M4x11	₺34		
VRT 10-M4,5x12	₺34		
VRT 11-M4,5x16	₺34		
VRT 12-M6x16	₺34		

**YEDEK PARÇALARDA İSKONTO ORANI FARKLIDIR.**  
DISCOUNT RATES ARE DIFFERENT FOR SPARE PARTS

## KÜRE VİDALARI / BALL SCREW

ÜRÜN KODU ORDER CODE	TL FİYAT TL PRICE	ÜRÜN DETAYI DETAILS PRODUCT	ÜRÜN RESMİ PRODUCT OF PICTURE
VKV 01-M3	₺34		
VKV 02-M4	₺34		
VKV 03-M5	₺34		
VKV 04-M5	₺34		
VKV 05-M6	₺34		
VKV 06-M8	₺34		

## ALYAN ANAHTARLARI / ALLEN KEYS

ÜRÜN KODU ORDER CODE	TL FİYAT TL PRICE	ÜRÜN DETAYI DETAILS PRODUCT	ÜRÜN RESMİ PRODUCT OF PICTURE
AA2	₺41		
AA3	₺40		
AA4	₺41		
AA5	₺41		
AA6	₺41		
AA6	₺41		

**YEDEK PARÇALARDA İSKONTO ORANI FARKLIDIR.**  
DISCOUNT RATES ARE DIFFERENT FOR SPARE PARTS

## TORX ANAHTARLARI / TORX KEYS

ÜRÜN KODU ORDER CODE	TL FİYAT TL PRICE	ÜRÜN DETAYI DETAILS PRODUCT	ÜRÜN RESMİ PRODUCT OF PICTURE
T 06	₺34		
T 08	₺34		
T 10	₺34		
T 15	₺40		
T 20	₺40		

**YEDEK PARÇALARDA İSKONTO ORANI FARKLIDIR.**  
DISCOUNT RATES ARE DIFFERENT FOR SPARE PARTS



**VORGEN®**

Tel: +90 332 **345 09 66**

Tel: +90 332 **345 09 67**

Fax: +90 332 **345 06 42**

Fevzi Çakmak Mah. Sila Cd.No: 71/5  
Karatay / KONYA / TURKEY  
[www.vorgen.com](http://www.vorgen.com)

[info@vorgen.com](mailto:info@vorgen.com)  
[export@vorgen.com](mailto:export@vorgen.com)